

Servo Drive E1100

Series E1100-RS/-DN/-CO**356****Series E1130-DP****358****Series E1100-GP****360**

Servo Drive E1100

Series E1100 Servo Drives are modular axis drives, with 32-bit position resolution and an integrated power element, for linear motors and rotary drives.

The drives are suitable for simplest, standard, and high-end positioning tasks, across the entire force range of the LinMot product range.



Connection to Machine Drive

The Series E1100 Servo Drives can be actuated by machine controls from any manufacturer or brand, via digital inputs and outputs, RS232 or RS485 serial interface, CanBus CANopen and DeviceNet interfaces, Profibus DP.

For complex motion sequences that are run in an overlaid position drive, B1100 small servo amplifiers are available, with analog velocity or force control and encoder simulation.

Process and Safety Interfaces

Fast process interfaces for direct processing of sensor signals are available as freely programmable analog and digital inputs, a fast trigger input, and a capture input.

The safe pulse inhibitor on Servo Drive with fieldbus interfaces allows safe stoppage of the drives via control signals, per EN 954-1, without interrupting the power supply.

Logic and Power Supply

The Servo Drives have two separate power supplies for the logic and power elements.

In an E-stop and safe stop of the drive, only the power element supply is cut off from the drive. The logic supply and the drive continue to run.

This has the advantage that the drive and linear motor do not need to be reinitialized when the machine is restarted, since all process data, including the current position of the linear motor, are still up to date.

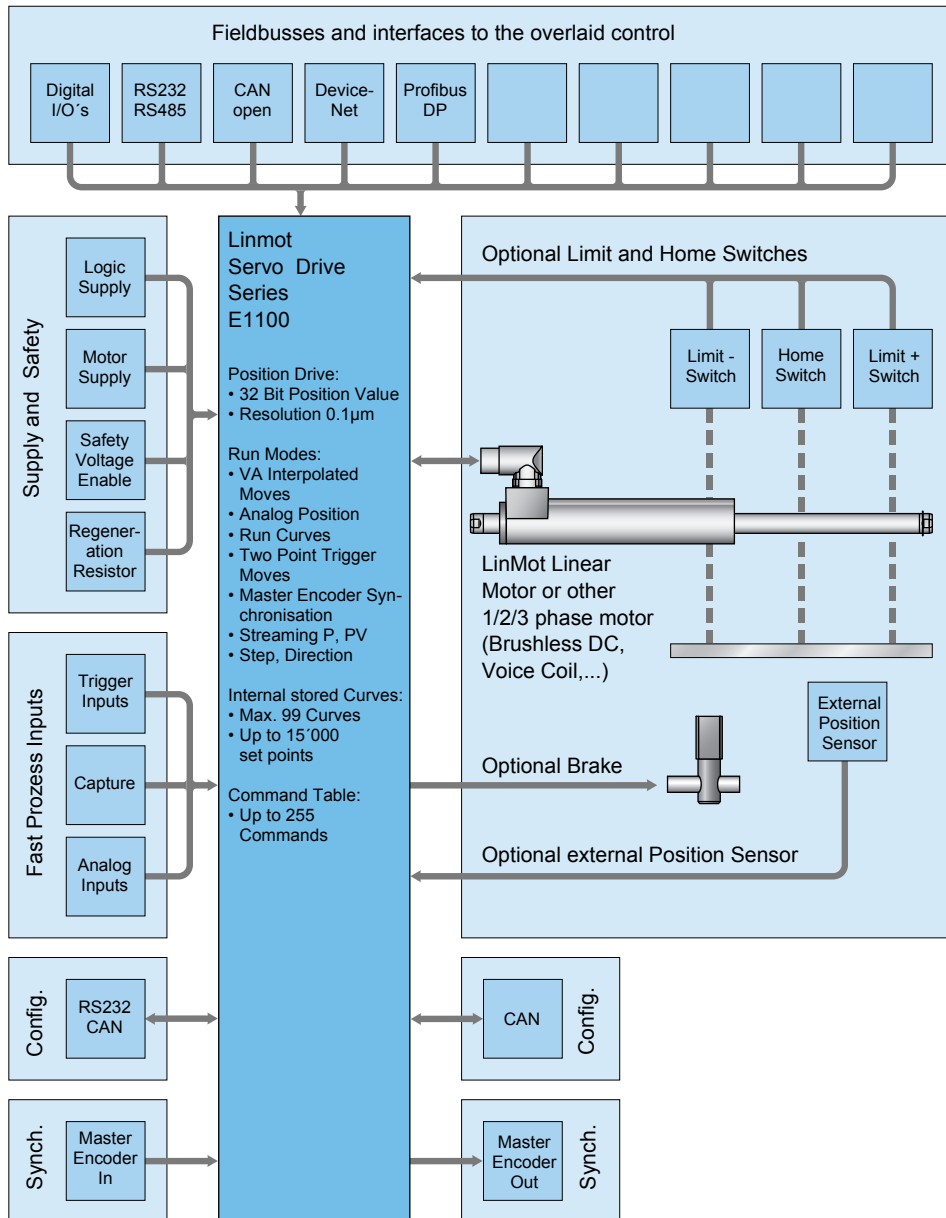

System Integration

Flexible hardware enables control of any 1/2/3-phase motors. Thus, low-power rotary servomotors, such as brushless DC motors, can be integrated in the same controls concept.

Additionally, the drives can be equipped with optional peripherals, such as reference and end stop switches, high-precision external position sensors, or a mechanical holding brake.

Series E1100 Servo Drives have analog and digital inputs and outputs, serial interfaces, fieldbuses. The user is therefore not dependent on the selection of the overlaid drive. An appropriate interface is available, with associated protocols, for any PLC or IPC solution.

With flexibility and a compact form factor, LinMot Series E1100 Servo Drives provide a complete solution for a flexible drive concept in single and multiple axis applications, with linear motors and other actuators.

Technology Functions

Technology functions are functional blocks that provide a complete solution for standard applications and frequently encountered, customer-specific problems. Technology functions can, for example, handle the complete sequence for winding textile yarns or glass fiber cables, or high-precision joining processes with force control can be implemented directly in the drive.

Option: Master Encoder Module

For synchronization to a mechanical master shaft, or a rotating main drive, the Axis (linear motors and rotary motors) can be coupled to an electronic main shaft via the Master Encoder Interface.

The encoder signal from the main shaft can be passed through by the Master Encoder Interface, so that any number of linear motors can be synchronized to the main shaft.

Motor Interfaces

E1100 Servo Drives provide all necessary interfaces to operate linear or rotary motors with optional external peripherals, such as end position and reference switches, a mechanical brake, or a high-resolution external position sensor.

In special applications, two drives can be synchronized with each other using the synchronization interface in master booster or master gantry mode.

Configuration

Parameterization and configuration of the Servo Drive is done via the RS232 interface on the front side, or CANBus for simultaneous configuration of several drives.

LinMot Talk user-friendly PC software is available for configuration. In addition to on-line documentation, LinMot Talk provides extensive debugging tools, such as an oscilloscope and an error inspector, for simple and rapid start-up of the Axis.

Fieldbus drives can also be configured directly by the overlaid control.

Interpolated Moves

Stroke [mm]

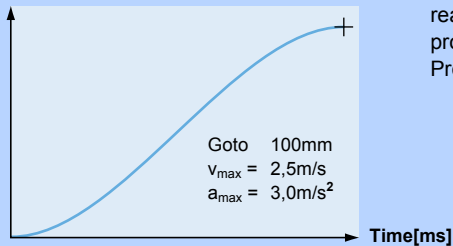

For direct position targets, using absolute or relative positioning, the desired position is reached using acceleration and velocity-limited motion profiles or jerk optimized Bestehorn profiles. Positioning commands can be invoked via the serial interfaces, CANopen, DeviceNet, Profibus or a trigger input.

Stroke range:	±100m
Position Resolution:	0.1µm (32Bit)
Velocity Resolution:	1.0µm/s (32Bit)
Velocity Resolution:	10.0µm/s ² (32Bit)

Time Curves

Stroke [mm]

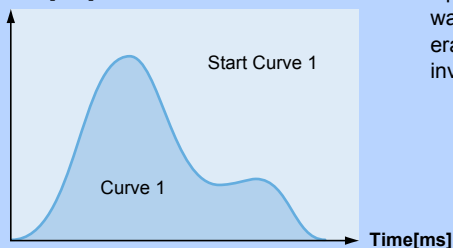

Up to 99 different time curves can be stored Series E1100 drives, with up to 16,000 individual waypoints. The motor can thus travel along time curves of any complexity, such as those generated by CAD programs and stored in the drive (Excel CSV format). The time curves can be invoked via the serial interface, fieldbuses, ETHERNET, or the trigger input.

Stroke range:	±100m
Position Resolution:	0.1µm (32Bit)
Motion profiles:	Max. 99 Time Curves
Curve points:	Max. 16'000 points

Profiled Moves

Stroke [mm]

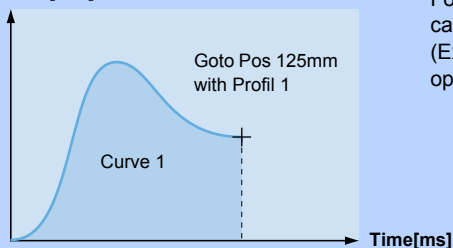

For travel to an absolute position, or shifting by a relative position, any desired motion rules can be stored besides the VA interpolator. They are stored in the drive as motion profiles (Excel CSV format). The positions can be approached, for example, with a sinusoidal motion to optimize power loss, or special reverse optimized motion profiles.

Stroke range:	±100m
Position Resolution:	0.1µm (32Bit)
Motion profiles:	Max. 99 Bewegungsprofile
Curve points:	Max. 16'000 Punkte

Setpoint Streaming

Stroke [mm]

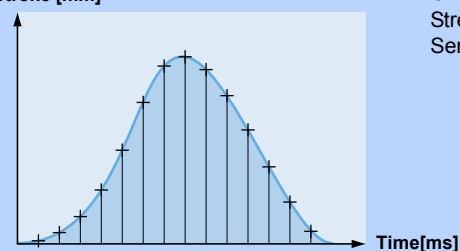

Overlaid NC drives with fieldbus interfaces communicate with the Servo Drives via "Position Streaming". The position and velocity calculated in the overlaid control is transmitted to the Servo Drive cyclically. The P, PV, or PVT mode is available for this transmission.

Position Resolution:	32 Bit
Velocity Resolution:	32 Bit
Interpolator:	3 kHz
cycle times:	2-5ms

Easy Steps

Input 1	Pos 125mm
Input 2	Pos 250mm
Input 3	Curve 1
Input 4	Pos -30mm
Input 5	Pos +12,5mm
Input 6	Curve 2
Input 7	Pos 2mm
Input 8	Pos -12,5mm

With the Easy Steps function, up to 8 positions or independent travel commands can be stored on the drive, and addressed via 8 digital inputs or fieldbus interfaces/ETHERNET.

Digital inputs:	max. 8
Interface:	X4
Resolution:	10 Bit
Scanning rate:	330µsec

Command Table

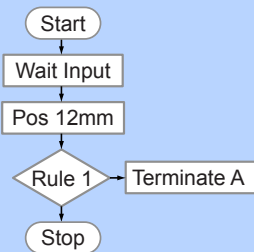

Entire motion sequences with up to 256 individual motion commands can be stored in the Command Table. This is primarily advantageous if complete motion sequences need to be executed very quickly, without dead time from the overlaid drive. In the Command Table, the programmer has access to all motion commands, internal parameters, and digital inputs and outputs.

Commands:	max. 256
Cycle time:	330µsec

Master Encoder Synchronization (MT)

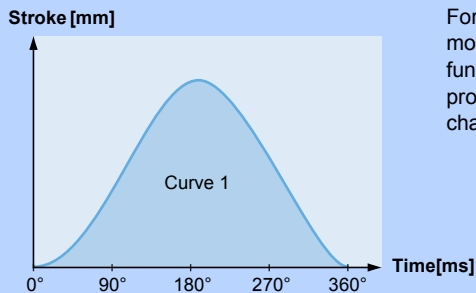

For synchronization to an external main or master shaft, the linear motor travels along the motion profiles stored in the drive, at the machine speed (machine angle 0...360°). Using this function, mechanical cam discs can be replaced with highly dynamic linear motors. The motion profiles can be freely defined, and the correct motion profile can be invoked during product changeover with no changeover time.

Motion profiles	Max. 99 curve profiles
Curve points:	Max. 16'000 points
Encoder Counter:	32 Bit
Encoder Input:	A/B/Z (RS422)
Max. counting frequency	Max. 4.5 MHz

Belt Synchronization

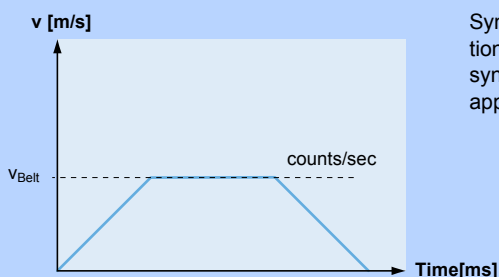

Synchronization to a belt speed can be done using the Master Encoder Interface or Step/Direction/Zero interface. Applications such as the "flying saw", synchronous loading or unloading, synchronous filling or labeling of bottles or containers on a conveyor belt, and many other applications can be implemented in this way.

Encoder Counter:	32 Bit
Encoder Input:	A/B/Z (RS422), max. 5 MHz
	STEP/DIR/ZERO
Max. counting frequency	Max. 4.5 MHz

Position Indexing

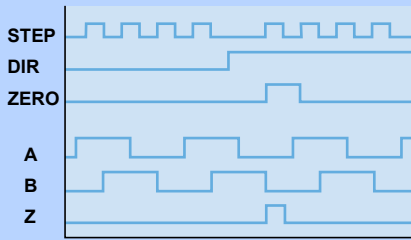

In position indexing, the linear motor is controlled like a stepper motor, using Step/Dir/Zero, or A/B/Z signals. The step distance is freely programmable from $1.5 \times 10^{-6} \mu\text{m}$ to 3.275mm./ step. The input signal can be used directly as the target position, or it can be filtered by the VA interpolator.

Operating Modes:	Step/Dir/Zero, A/B/Z
Inputs:	differential RS422 (X10)
Step distance:	$1.5 \times 10^{-6} \mu\text{m}$3.275mm, 32 Bit
Max. counting frequency:	4.5 MHz

Master-Booster Synchronisation

Master-Booster Synchronisation

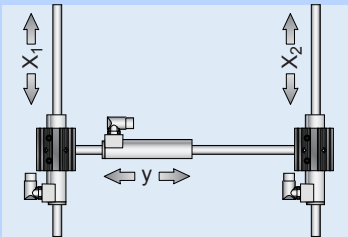

Using master-slave synchronization, two linear motors can be synchronized via a serial communications connection between two drives, so that the overlaid drive can control them as a single axis.

Master Booster Synchronization

Master booster synchronization is used to double the force when two motors are mechanically rigidly connected to each other.

Master-Gantry Synchronisation

Master-Gantry Synchronisation

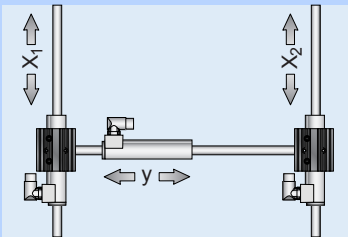

Using master-slave synchronization, two linear motors can be synchronized via a serial communications connection between two drives, so that the overlaid drive can control them as a single axis.

Master Gantry Synchronization

Master gantry synchronization is used for portal designs with two parallel Axis at different locations.

Analog Position

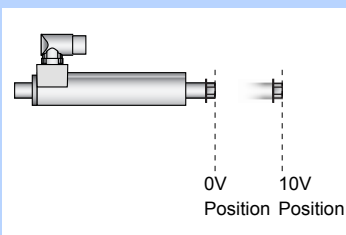

For an analog position target, the linear motor travels to a position proportional to the input voltage. The position is either scanned continuously, or only after a rising edge of the trigger signal. In order to prevent uncontrolled jumps in position, the motor travels to the positions with a programmable maximum acceleration and velocity (VA interpolator).

Inputs:	Analog Input (X4.4)
Voltage range:	0-10VDC
Resolution:	10 Bit
Scanning rate:	330µsec

Easy Steps Parameter Scale

Maximum Force [0...10V => 0...100%]

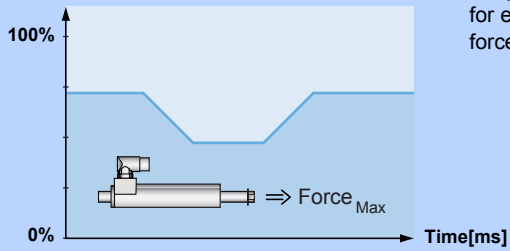

Easy Steps provide the ability to parameterize internal parameters using two analog inputs. If, for example, the maximum motor current is read at an analog input, then the maximum motor force can be provided as analog for freely programmable joining processes.

Inputs:	2 x Analog (X4.4, X4.7)
Voltage range:	0-10VDC
Resolution:	10 Bit
Resolution	330µsec

Winding Application

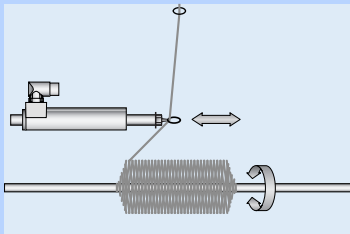

For winding textile yarns, glass fiber optics, or wires, a complete functional block is available that controls the entire sequence of a complete winding process.

Closed Loop Force Control

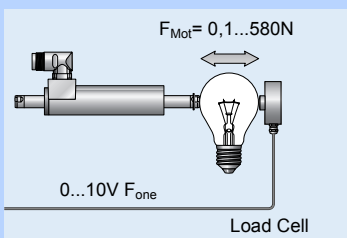

Using the Force Control technology function, precise joining processes can be implemented reliably and reproducibly with high-precision force control. For force control, the current motor force is measured with a load cell and controlled in the drive. Joining process or quality checks with high requirements for applied force can be implemented.

Analog Input:	0-10V
Resolution:	10 Bit
Min. Force Resolution:	0.1N

LinMot Talk

LinMot Talk configuration software is a Windows-based interface that supports the user during start-up and configuration of the LinMot Servo Drives. The software has a powerful, modular, graphical interface that covers all the tasks surrounding the LinMot Servo Drive. Great emphasis was placed on a high level of user-friendliness during development.

In addition to start-up, LinMot Talk can also be used for training purposes and for actuation via serial interfaces, fieldbuses, or industrial ETHERNET. Using the integrated Control Panel, the user has direct access to control and status words, as well as all commands that are invoked for operation by the overlaid control. The user learns the meaning of the control and status words easily, and can get to know the individual commands in the Motion Command Interface.

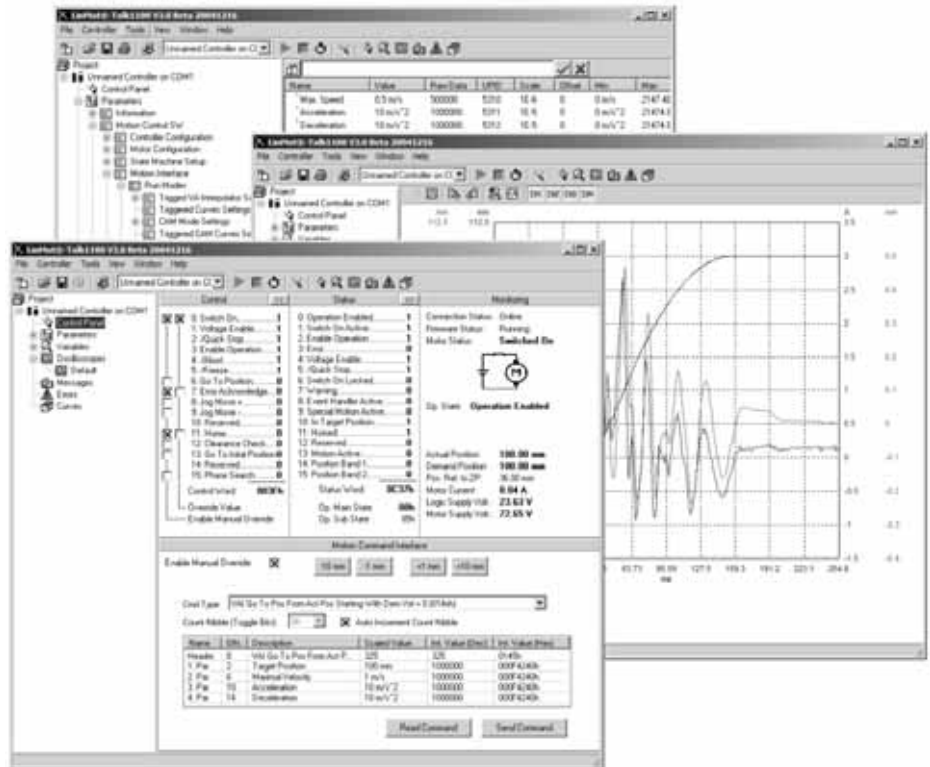

Start-up and Analysis Tools

Using the LinMot Talk PC interface, LinMot Servo Drives are configured. Additionally, the drives can be monitored during operation with the machine running, and the current motion sequences, as well as earlier warnings and error messages, can be analyzed in detail (monitoring).

Single or Multiple Axis Configuration

For start-up and monitoring, the Servo Drive is connected to a PC via the RS232 interface on the front or via CAN Bus. If the connection to the PC is made via USBSCAN converter (see accessories,) then up to 16 Axis can be configured and monitored simultaneously.

Online Help & Documentation

Using the multilingual Online Help, the user can find useful information about the individual parameters and their functionality. All manuals and installation instructions can then be called up on the PC, after LinMot Talk is installed, via the Windows Start Menu, or they can be directly generated in HTML format.

Parameterization

Using the "Parameter Inspector," the drives are parameterized in a simple manner. The user has a wide range of adjustments available for operating modes, error management, warning messages, and regulating parameters. Entire parameter sets can be stored, loaded, and printed out.

The "Curve Inspector" allows creation of motion profiles. In addition, existing curves can be loaded, stored, edited, combined, and printed out. Further, complex motion sequences can be generated as desired in MS Excel, and loaded into the drive.

Optimization

The integrated 8-channel oscilloscope helps the user during start-up and optimization of the drive system. Internal variables, such as the target and actual position, can be shown in real time on the screen, and then printed out. The displayed data can be stored in CSV format for further processing in MS Excel, or stored for documentation purposes.

Monitoring

The user has many tools available for monitoring and analysis of the drive. Both current warnings and fault messages, and older fault messages stored in non-volatile memory, state changes, and many other pieces of information can be obtained.

Internal variables, drive parameters, inputs, and outputs can be combined as desired and display cyclically.

Using the oscilloscope, internal parameters can be charted when warning and fault messages occur.

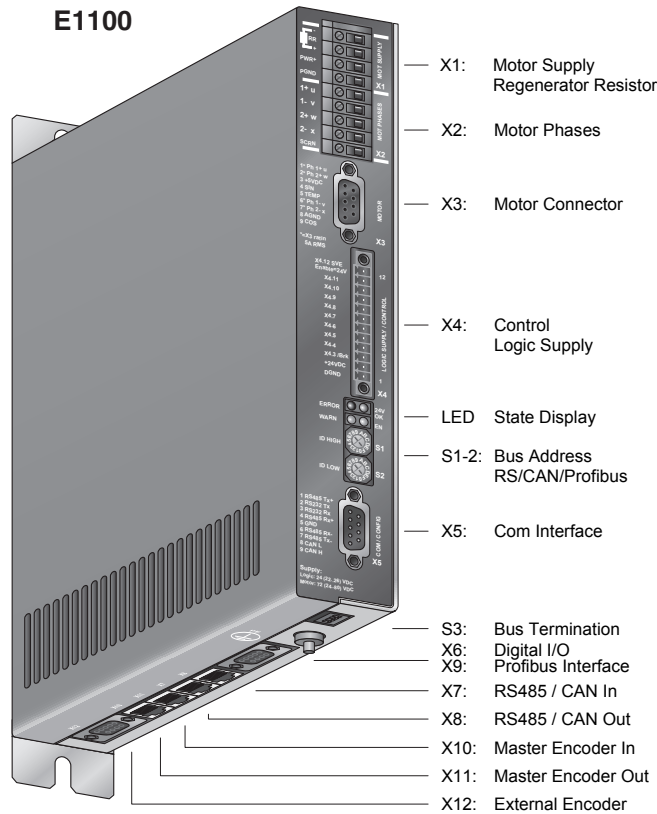

		E1100-RS	E1100-CO	E1100-DN	E1100-DP	E1100-GP
Interfaces						
X1	Motor Supply Regeneration Resistor	●	●	●	●	●
X2	Motor Phases	●	●	●	●	●
X3	Motor Connector	●	●	●	●	●
X4	Control / Logic Supply	●	●	●	●	●
X5	COM Interface	RS232	●	●	●	●
		RS485	●	●	●	●
		CAN	●	●	●	●
X6	Digital I/O					●
X7	RS485 / CAN In	●	●	●	●	
X8	RS485 / CAN Out	●	●	●	●	
X9	Profibus Interface				●	
X10	Master Encoder In	●	●	●	●	●
X11	Master Encoder Out	●	●	●	●	●
X12	External Encoder (D-Sub 9)	●	●	●	●	●
X13	External Encoder (D-Sub 15)					
LED	State Display	●	●	●	●	●
S1	Bus Address RS/CAN/ETH High	●	●	●	●	●
S2	Bus Address RS/CAN/ETH Low	●	●	●	●	●
S3	Bus Termination	●	●	●	●	●

E1100-RS
E1100-RS-HC
E1100-RS-XC

E1100-DN
E1100-DN-HC
E1100-DN-XC

E1100-CO
E1100-CO-HC
E1100-CO-XC

RS 232

RS 485

DeviceNet

CANopen

- ✓ Absolute & Relative Positioning
- ✓ Travel Along Time Curves
- ✓ Positioning using Motion Profiles
- ✓ Internally stored Motion Commands
- ✓ Internally stored Motion Sequences
- ✓ Master Encoder Synchronization
- ✓ Synchronization to Belt Speed
- ✓ Step and Direction Interface
- ✓ Position Streaming
- ✓ Master-Slave Synchronization
- ✓ Analog Position Target
- ✓ Analog Parameter Scaling
- ✓ Winding Function Block
- ✓ Force Control Technology Function
- ✓ Customer-Specific Functions

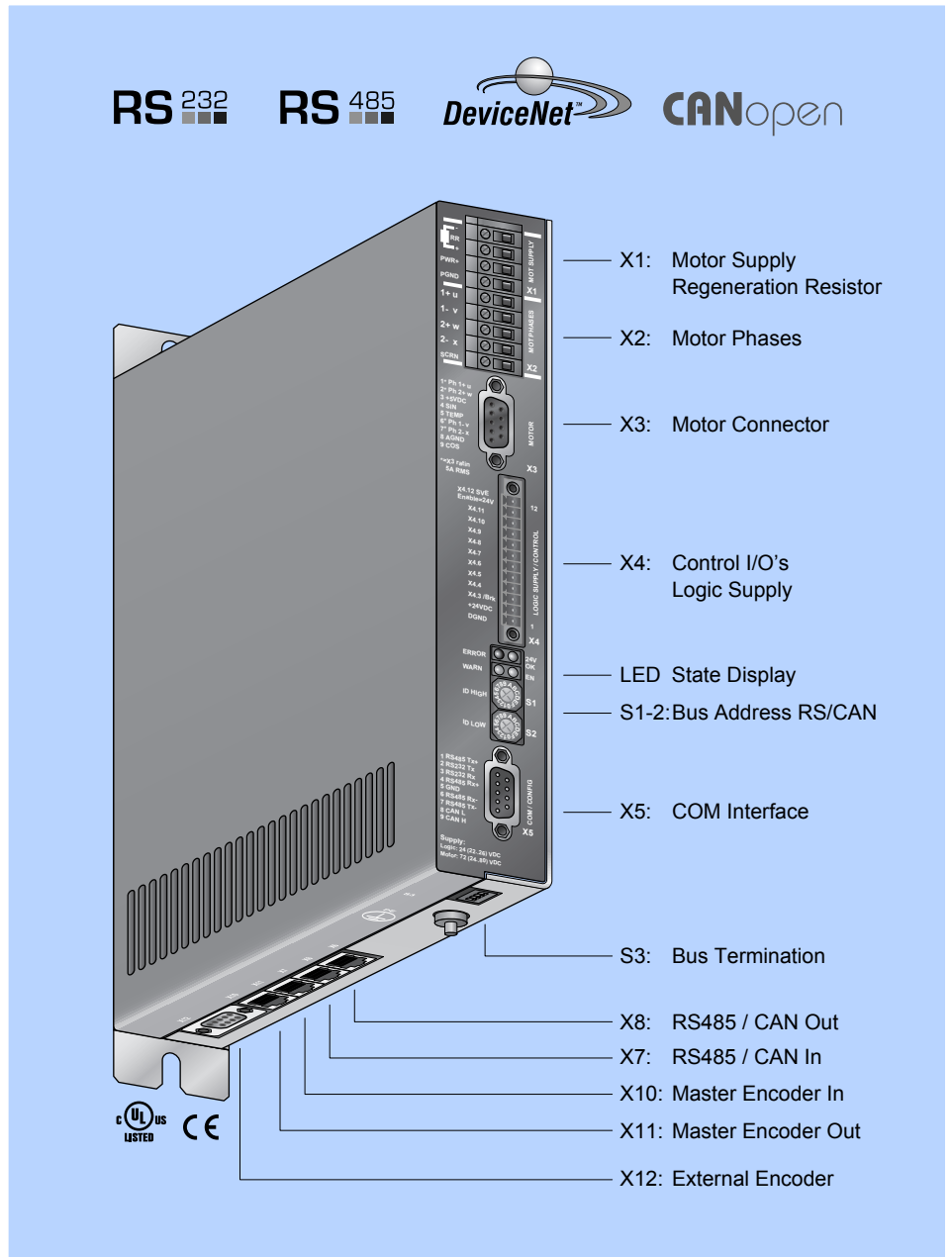

LinRS Serial Interface

The LinMot Series E1100-RS Servo Drives support the LinRS serial communication protocol. LinRS is a proprietary protocol for actuating LinMot Servo Drives via the RS 232, RS 422, and RS 485 interfaces.

If the drive is actuated by the overlaid control via the serial interface, then this is configured from the PC via CANBus. The USBSCAN converter (item no. 0150-3134), supported by LinMot Talk, is used for this.

Adjustable Baud rates: 9.6-115.2kBaud

CANopen

LinMot CO drives, with integrated CANopen interface, support the CiA DS301 communication profile.

The following resources are available: 3 T_PDO, 3 R_PDO, 1 T_SDO, 1 R_SDO

The following protocols are supported by the CO drives:

- NMT Error Control (Nodeguarding Protocol or HeartBeat Protocol)
- PDO (Transmission type 254 and 1)
- SDO Upload and Download - NMT (Start, Stop, Enter PreOp, Reset Node, Reset Communication)
- Boot-Up Message

DeviceNet

Series E1100-DN drives feature an integrated DeviceNet interface. With the DeviceNet interface, even complicated motion sequences can be realized with the highest possible flexibility.

The drive can be actuated and monitored via the DeviceNet connection.

E1100-DN are UCMM Group 3-capable slaves, and support polled IO runtime data transfer

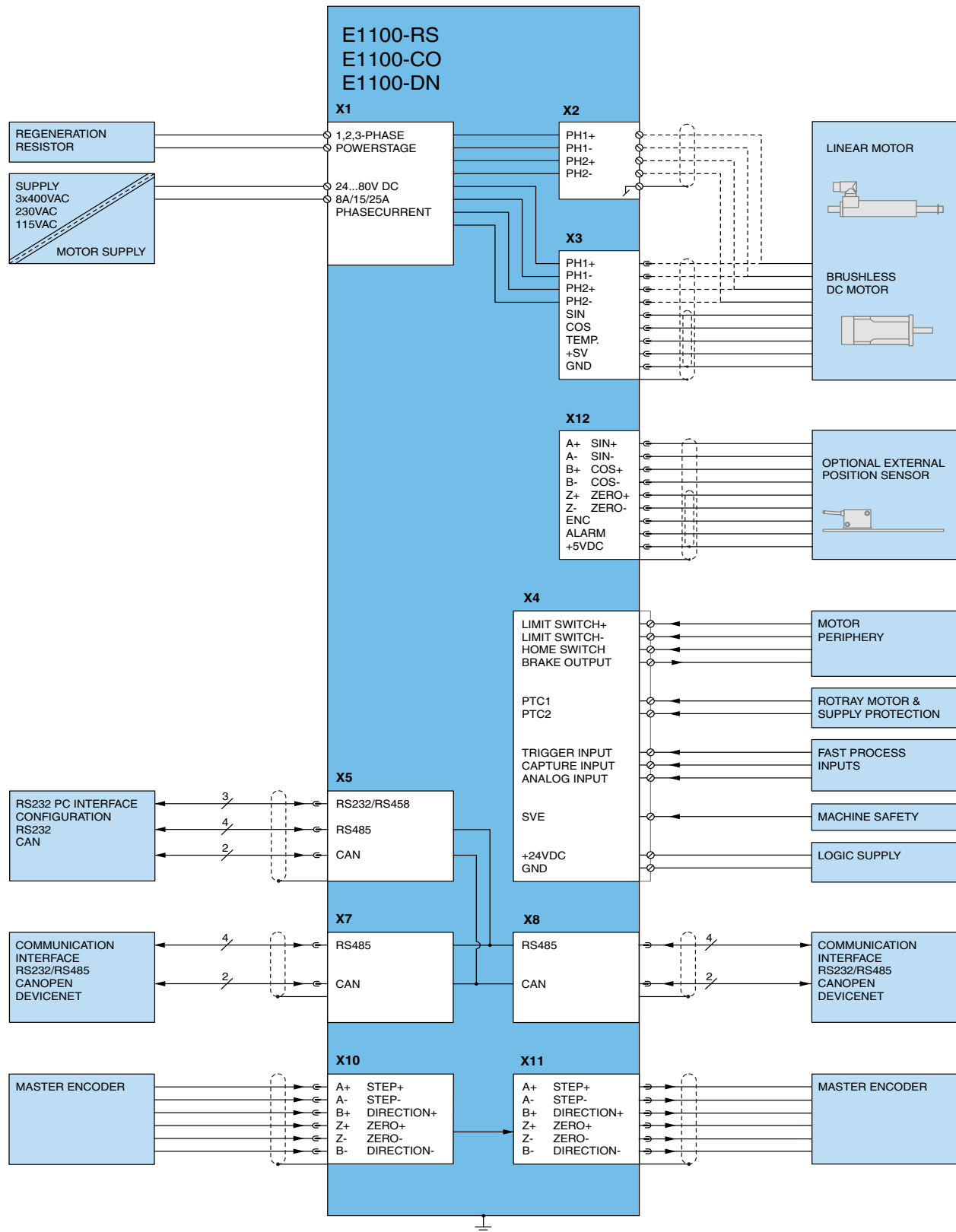

Item	Description	Part Number
E1100-RS	RS232/485 Drive (72V/8A)	0150-1677
E1100-RS-HC	RS232/485 Drive (72V/15A)	0150-1678
E1100-RS-XC	RS232/485 Drive (72V/25A)	0150-1862
E1100-CO	CANopen Drive (72V/8A)	0150-1681
E1100-CO-HC	CANopen Drive (72V/15A)	0150-1682
E1100-CO-XC	CANopen Drive (72V/25A)	0150-1683
E1100-DN	DeviceNet Drive (72V/8A)	0150-1679
E1100-DN-HC	DeviceNet Drive (72V/15A)	0150-1680
E1100-DN-XC	DeviceNet Drive (72V/25A)	0150-1863

E1130-DP
E1130-DP-HC
E1130-DP-XC

- ✓ Absolute & Relative Positioning
- ✓ Travel Along Time Curves
- ✓ Positioning using Motion Profiles
- ✓ Internally stored Motion Commands
- ✓ Internally stored Motion Sequences
- ✓ Master Encoder Synchronization
- ✓ Synchronization to Belt Speed
- ✓ Step and Direction Interface
- ✓ Position Streaming
- ✓ Master-Slave Synchronization
- ✓ Analog Position Target
- ✓ Analog Parameter Scaling
- ✓ Winding Function Block
- ✓ Force Control Technology Function
- ✓ Customer-Specific Functions

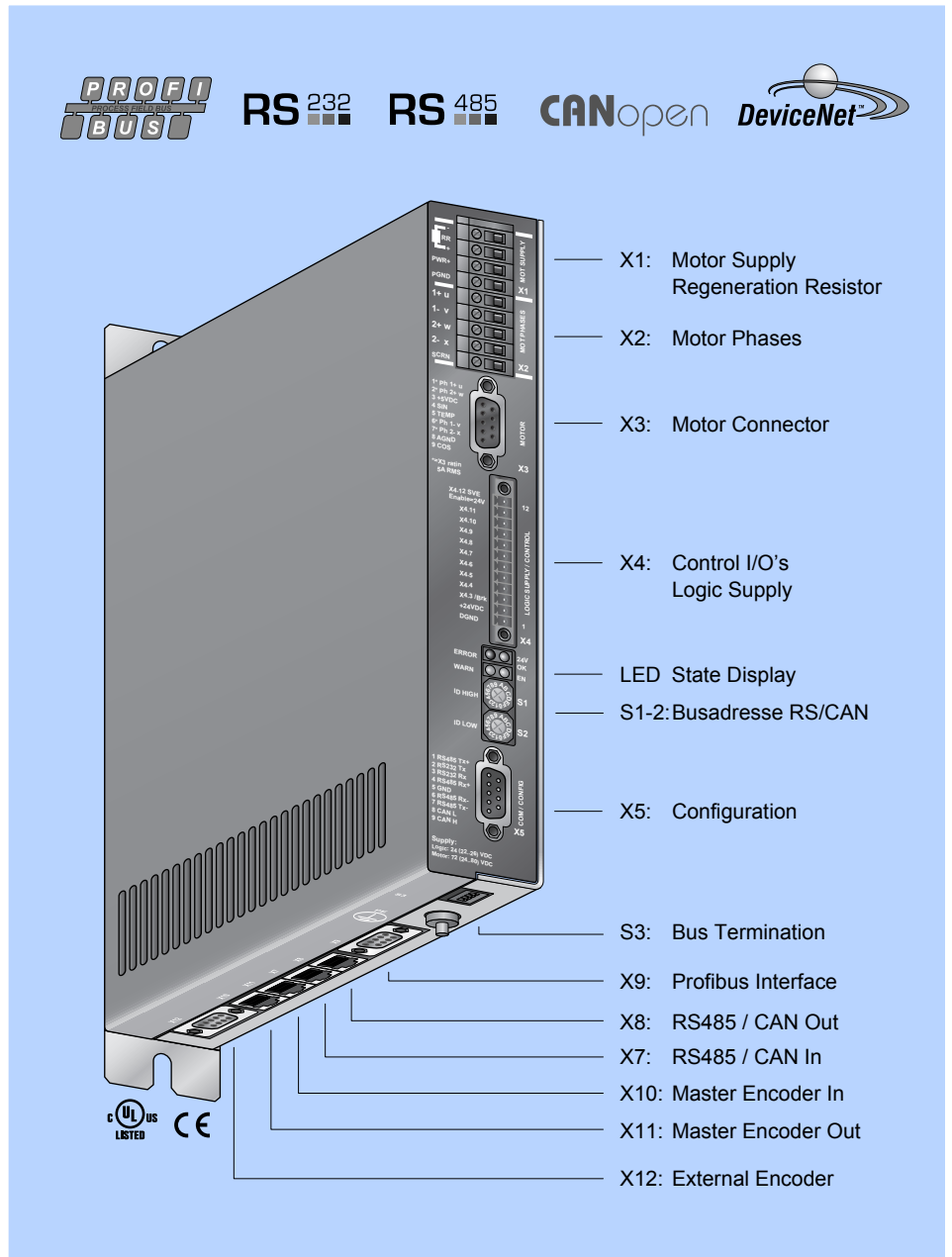

Profibus DP

DP Servo Drives feature an integrated PROFIBUS-DP interface. PROFIBUS-DP provides the user with a standardized fieldbus interface for rapid data interchange between the Servo Drive and the overlaid control.

With fast data transfer and command initiation, as well as simple system integration, the Profibus drives are the ideal solution for applications with motions and sequences that change frequently, such as are required, for example, in flexible machines and systems with automatic format changes.

The PROFIBUS-DP interface supports all Baud rates from 9.6 Kbits/s to 12 Mbit/s. The maximum net data quantity exchanged in cyclical data traffic is 64 bytes per cycle. The smallest achievable bus cycle time is 100 µs.

The structure and scope of cyclical data can be collected from any individual data modules into an overall data quantity when planning the system.

A GSD device master file is provided for open planning in conformance with the PROFIBUS-DP standard.

The 9-pole Profibus connector on the front side provides power for an external bus termination. A positive directional control signal is provided to control repeaters or optical fibers.

All signals on the PROFIBUS connector are galvanically separated.

The PROFIBUS-DP address is set by two hex code switches (ID1 and ID2).

All addresses permitted by the standard are supported (0..125).

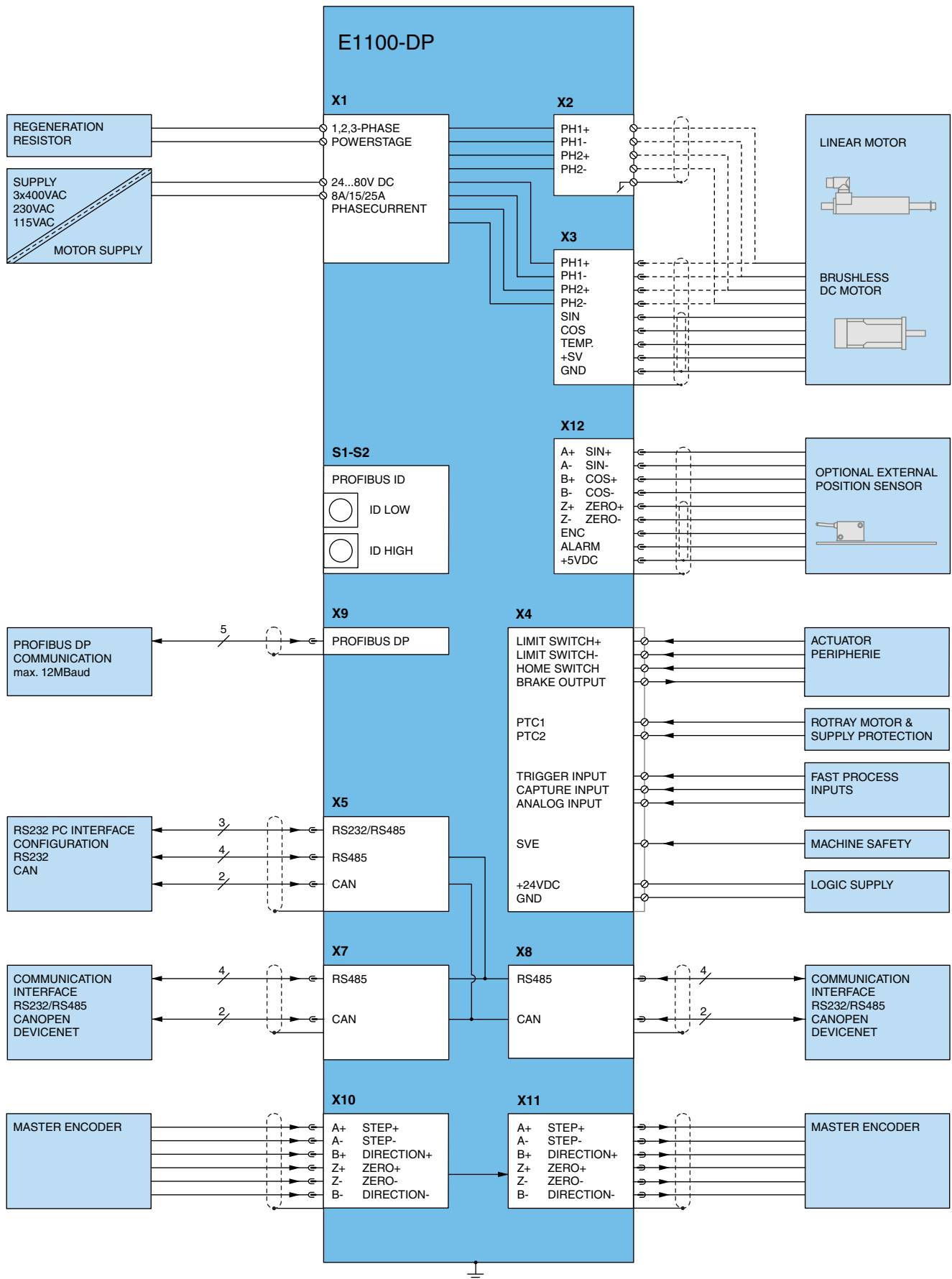

Item	Description	Part Number
E1130-DP	Profibus DP Drive, (72V/8A)	0150-1667
E1130-DP-HC	Profibus DP Drive, (72V/15A)	0150-1668
E1130-DP-XC	Profibus DP Drive, (72V/25A)	0150-1861

E1100-GP
E1100-GP-HC
E1100-GP-XC

RS 232

RS 485

CANopen

DeviceNet™

- ✓ Absolute & Relative Positioning
- ✓ Travel Along Time Curves
- ✓ Positioning using Motion Profiles
- ✓ Internally stored Motion Commands
- ✓ Internally stored Motion Sequences
- ✓ Master Encoder Synchronization
- ✓ Synchronization to Belt Speed
- ✓ Step and Direction Interface
- ✓ Position Streaming
- ✓ Master-Slave Synchronization
- ✓ Analog Position Target
- ✓ Analog Parameter Scaling
- ✓ Winding Function Block
- ✓ Force Control Technology Function
- ✓ Customer-Specific Functions

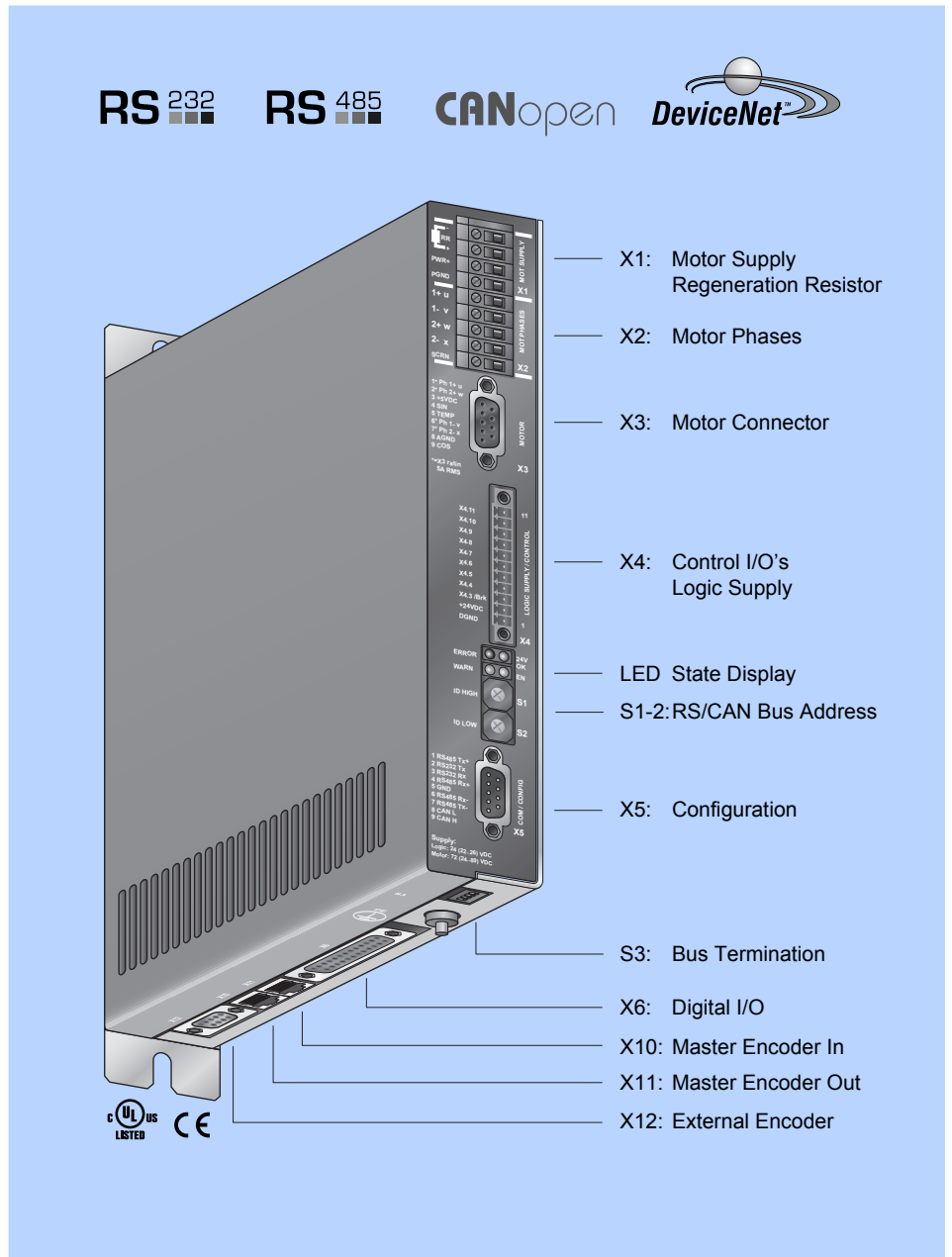

General Purpose Drive

Series E1100-GP drives are multifunctional Servo Drives, on which the firmware from the following drives can be installed:

- Series E1100-RS
- Series E1100-CO
- Series E1100-DN

All functions of the drives listed above, except for safe pulse inhibitors (X4.12) are available in the Series E1100-GP Servo Drives.

For actuation by an overlaid drive, the following digital, serial, and fieldbus interfaces are available:

- LinRS via RS232, RS485 and RS422
- CANopen - DeviceNet

In addition to actuation via serial interfaces and fieldbuses, Series E1100-GP drives can use direct addressing of up to 256 commands in the Command Table, via 8 digital inputs (X6).

Even complex drive tasks and complete, automated sequences can be controlled using simple digital signals.

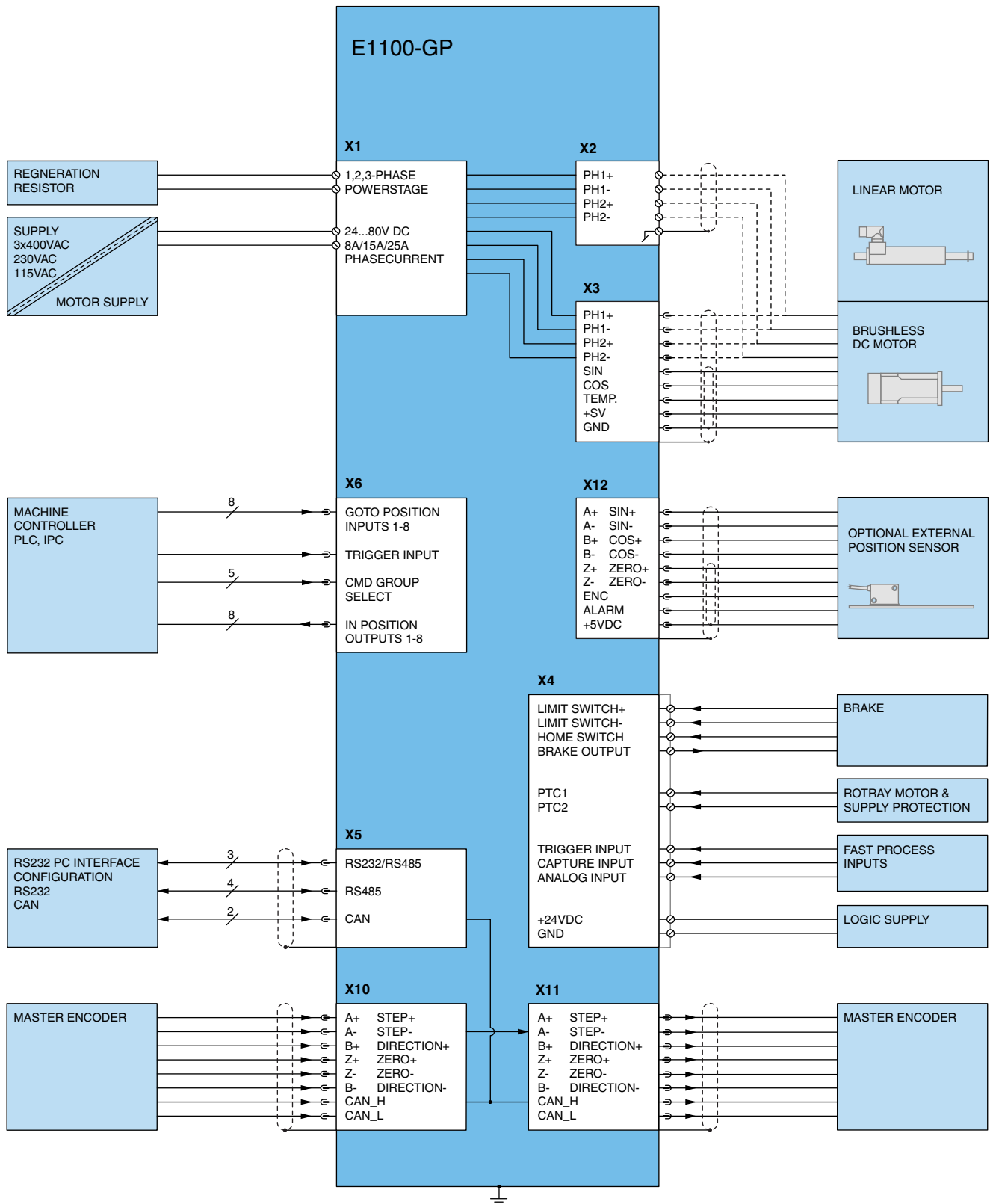

Item	Description	Part Number
E1100-GP	General Pupose (72V/8A)	0150-1665
E1100-GP-HC	General Pupose (72V/15A)	0150-1666
E1100-GP-XC	General Pupose (72V/25A)	0150-1864

X1 Motor Supply / Regeneration Resistor

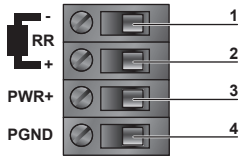

Screw Terminals
2.5 mm² (AWG14)

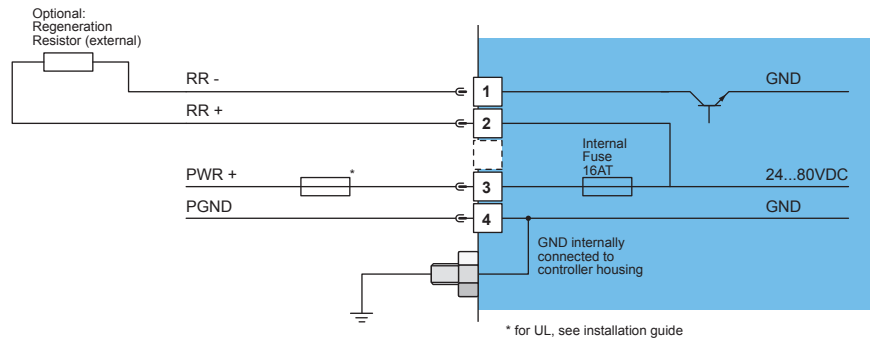

Motor Supply:

Motor Supply Voltage 24...80VDC.
Absolute max. Rating 72VDC + 20%



If motor supply voltage is exceeding 90VDC, the drive will go into error state

X2 Motor Phases

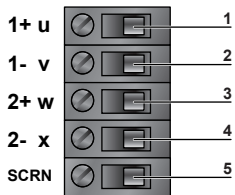

Screw Terminals
1.5-2.5mm²
(AWG16-14)

Nr.	Designation	LinMot Linear Motor	Color	3-Phase-Motor
1	PH1+ /U	Motor Phase 1+	red	Motor Phase U
2	PH1- /V	Motor Phase 1-	pink	Motor Phase V
3	PH2+ /W	Motor Phase 2+	blue	Motor Phase W
4	PH2- /	Motor Phase 2-	grey	
5	SCRN	Shield		

- If the RMS current is not higher than 5Arms, respectively 7.5Apeak, the phases can be connected to X3.
- Do NOT connect X2 and X3.

X3 Motor

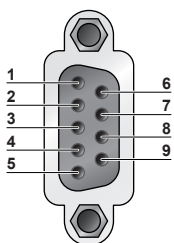

DSUB-9

Nr	LinMot Linear Motor	3-Phase-Motor
1	Motor Phase 1+	Motor Phase U
2	Motor Phase 2+	Motor Phase W
3	+5VDC	
4	Sine	Hall U
5	Temperature	Hall W
6	Motor Phase 1-	Motor Phase V
7	Motor Phase 2-	
8	AGND	
9	Cosine	Hall V
Case	Shield	

- Use X2 for motor phase wiring if phase current exceeds 5Arms or 7.5Apeak
- Use +5V (X3.3) and AGND (X3.8) only for motor internal Hall Sensor supply (max. 100mA)
- Do NOT connect AGND (X3.8) to ground or earth!

Motor Motor wiring

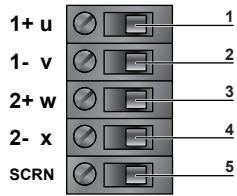

X2: Screw Terminals

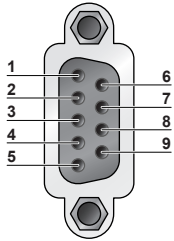

X3: DSUB-9 (f)

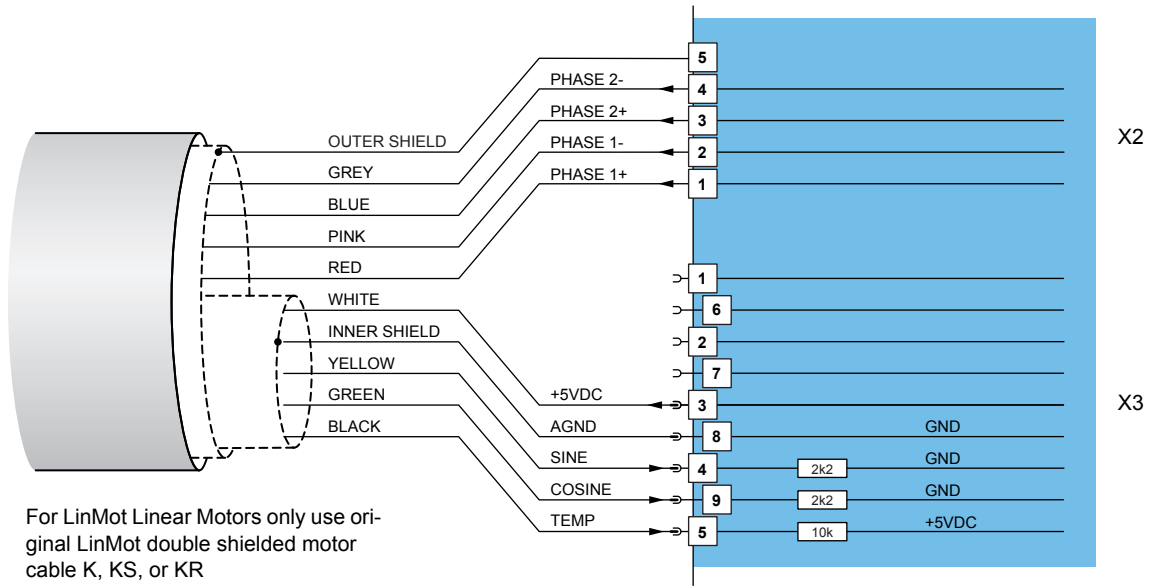

Motor Motor wiring for phase current below 5Arms and below 7.5Apeak

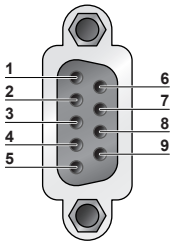

X3: DSUB-9 (f)

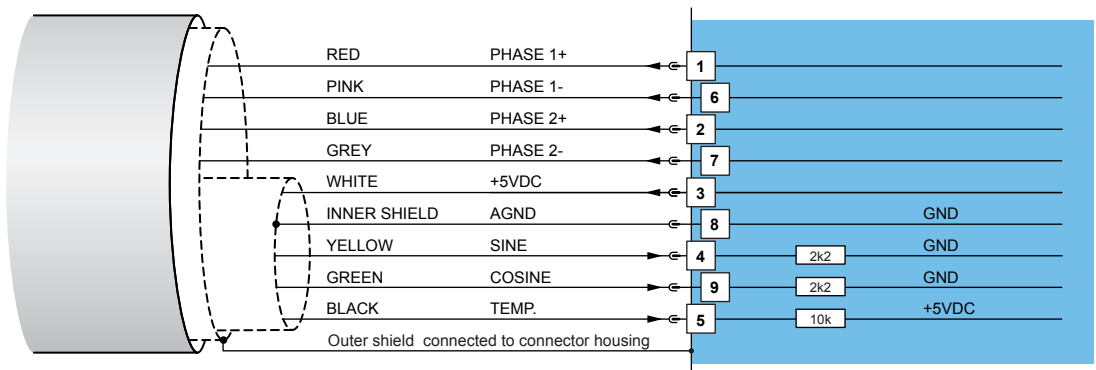

S1-3 Address Selectors / Bus Termination



Switch	Function	Notes
S1	Bus ID High (0...F)	HEX-Switches for Bus ID address range 0.255
S2	Bus ID Low(0...F)	
Switch E1100	Switch 1: RS232 "off" / RS485 "on"	Select serial RS23 or RS485 Factory settings: all switches "off"
S3	Switch 2: RS485 Termination on/off	
	Switch 3: CAN Termination on/off	
	Switch 4: Bus Interface on/off	

X4: 12pin

Control / Supply E1130-DP, E1100-CO, E1100-DN, E1100-RS

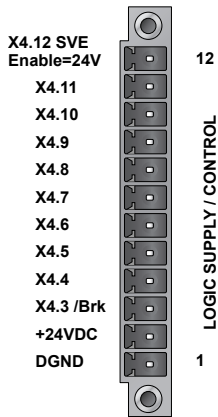

Phoenix MC1,5/12-STF-3,5
0.25-1.5mm² (AWG24-16)

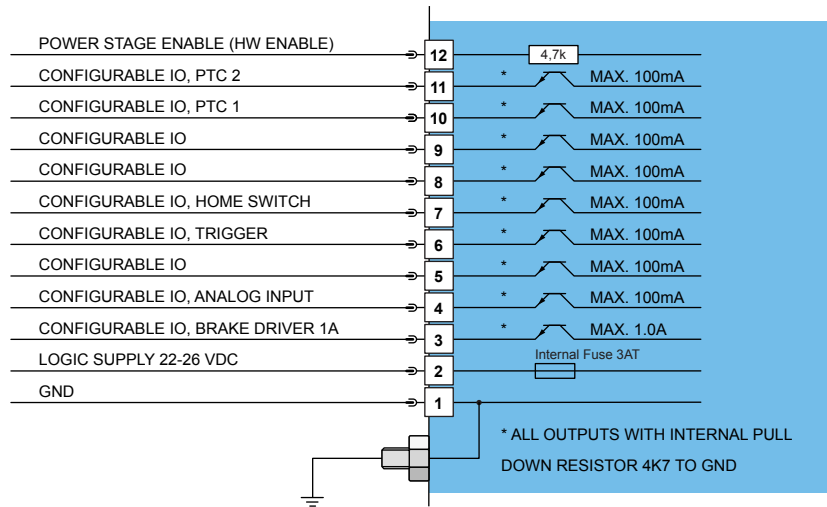

X4: 11pin

Control / Supply E1100-GP

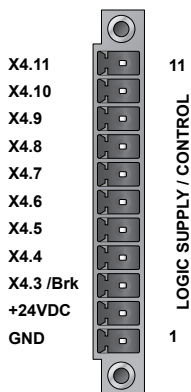

Phoenix MC1,5/11-STF-3,5
0.25-1.5mm² (AWG24-16)

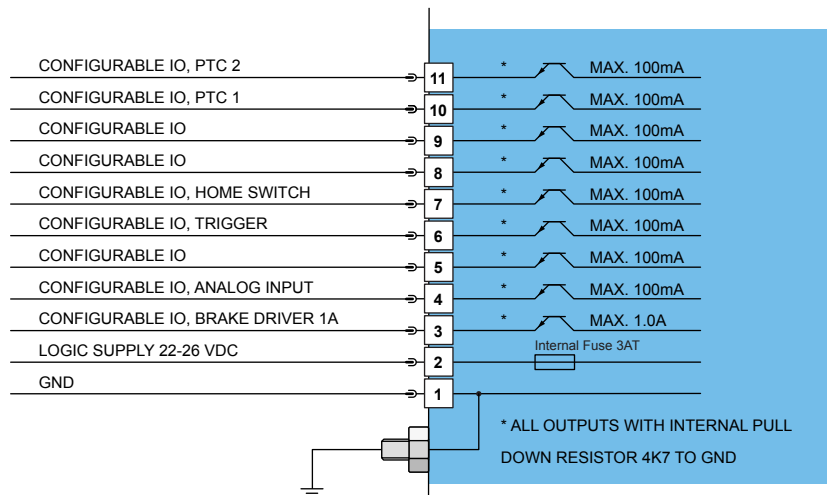

No		Description	
12	Input	Safety Voltage Enable	Power Stage Enable (HW Enable)
11	I/O	X4.11	Configurable IO, PTC 2
10	I/O	X4.10	Configurable IO, PTC 1
9	I/O	X4.9	Configurable IO
8	I/O	X4.8	Configurable IO
7	I/O	X4.7	Configurable IO, Home Switch
6	I/O	X4.6	Configurable IO, Trigger
5	I/O	X4.5	Configurable IO
4	I/O	X4.4	Configurable IO, Analog Input
3	I/O	X4./Brk	Configurable IO, Brake Driver 1A
2	+24VDC	Supply	Logic Supply 22-26 VDC
1	GND	Supply	Ground

Inputs	24V / 1mA
Outputs	24V / max.100mA
Brake Output (X4.3)	24V / max.1.0A
Sample Rate	Inputs/Outputs 1ms, Trigger Input 0.315msec
Supply	24VDC / typ. 400mA / max. 2.1A (if all outputs "on" with max. load.)
Wiring	0.25-1.5mm ² (AWG24-16)

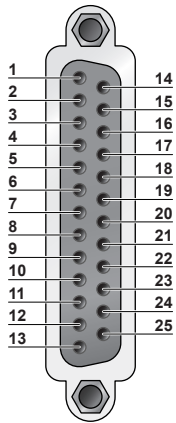

X6: DSUB-25 (f)

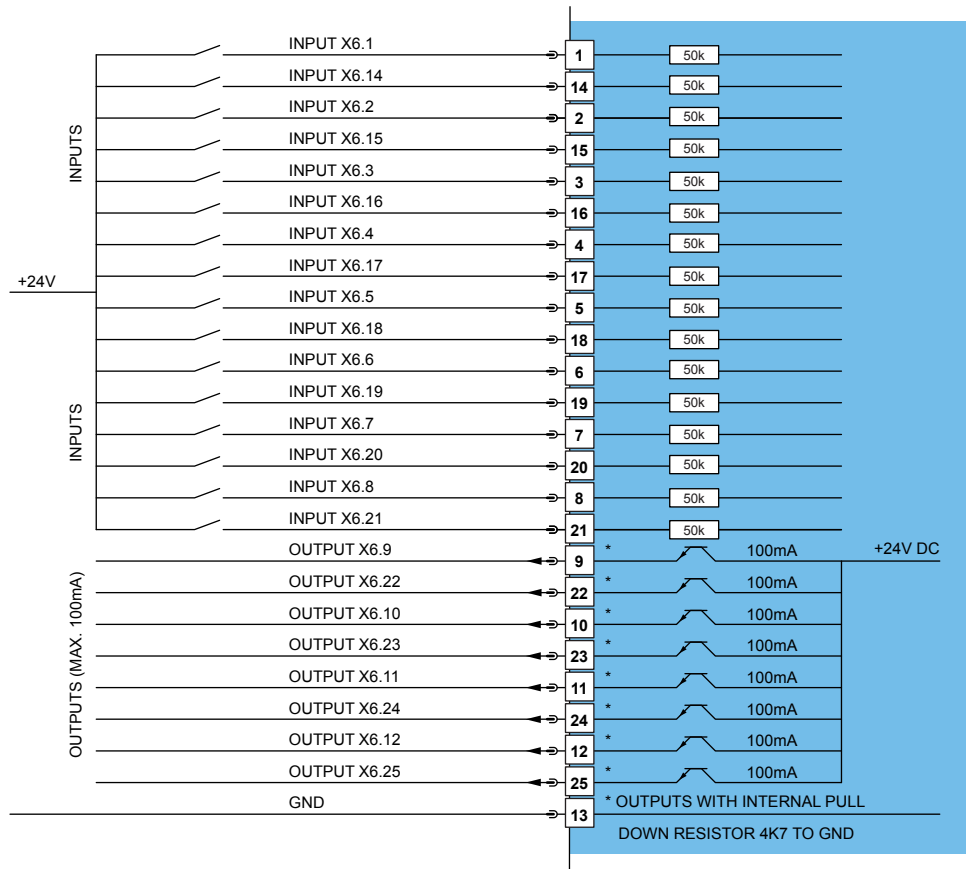

All Inputs: Direct interfacing to digital 24VDC PLC outputs.
 Input current: 1mA
 low level: -0.5...5VDC
 high level: 15...30VDC
 Sample rate: 625µs

All Outputs: Short circuit and overload protected high side switches
 Voltage: 24VDC
 Max. current: 100mA
 High Level: 15...30VDC
 Update rate: 625µs

Outputs may directly drive inductive loads

X5 COM

COM Interface

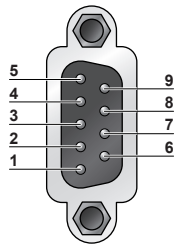

X5: DSUB-9 (m)

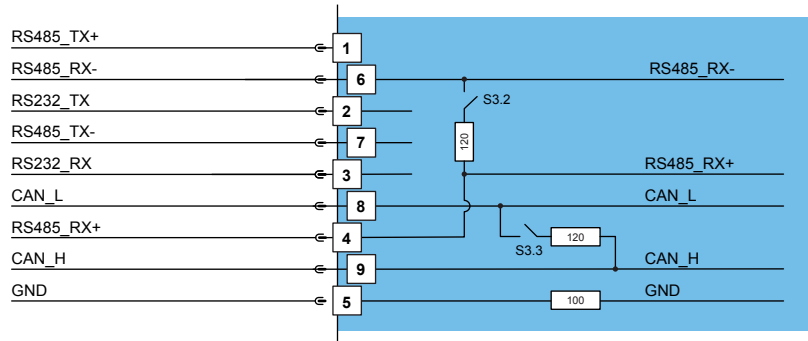

RS232: Configuration on all Drives: use 1:1 connection cable to PC

LED

State Display

Green:

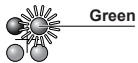

24VDC Logic Supply OK

Stat A Yellow:

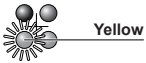

Motor Enabled

Stat B Yellow:



Warning

Red:



Error

X7-X8

RS485/CAN

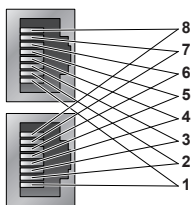

RJ-45

Nr		
1	RS485_Rx+	A
2	RS485_Rx-	B
3	RS485_Tx+	Y
4	GND	
5	GND	
6	RS485_Tx-	Z
7	CAN_H	
8	CAN_L	
Case	Shield	

- X7 internally connected to X8 (1:1 connection)
- Use twisted pair (1-2, 3-6, 4-5, 7-8) cable for wiring.
- The built in CAN and RS485 terminations can be activated by S3.2 and S3.3.

X9

Profibus DP

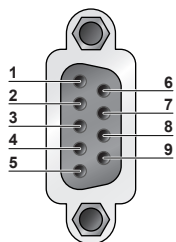

DSUB-9

Nr		
1	-	
2	-	
3	RxD/TxD-P	
4	CNTR-P	
5	GND	(galvanically seperated)
6	+5V	(galvanically seperated)
7	-	
8	RxD/TxD-N	
9	-	
Case	Shield	

Max. Baud rate: 12 Mbaud

X10-X11

Master Encoder IN (X10) / Master Encoder OUT (X11)

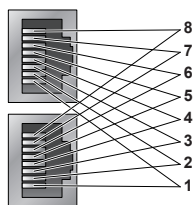

RJ-45

Nr	Incremental	Step/Direction	EIA/TIA 568A colors
1	A+	Step+	Green/White
2	A-	Step-	Green
3	B+	Direction+	Orange/White
4	Z+	Zero+	Blue
5	Z-	Zero-	Blue/White
6	B-	Direction-	Orange
7	CAN_H*	CAN_H*	Brown/White
8	CAN_L*	CAN_L*	Brown
Case	Shield	Shield	

*only on E1100-GP

- CAN internally connected to X7, X8
- CAN und RS485 Termination can be turned on by S3.2 alt. S3.3.
- X10 an X11: Use twisted pair (1-2, 3-6, 4-5, 7-8) cable for wiring.
- X10 Master Encoder Inputs: Differential RS422, max. Input Frequency 4.5MHz
- X11 Master Encoder Outputs: Amplified RS422 differential signals from Master Encoder IN (X10)

X12

External Positions Sensor

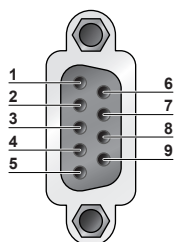

DSUB-9

Nr	Incremental:	Sin/Cos
1	+5V DDC	+5V DC
2	A-	SIN-
3	B-	COS-
4	Z-	ZERO-
5	GND	GND
6	A+	SIN+
7	B+	COS+
8	Z+	ZERO+
9	Enc. Alarm	Enc. Alarm
Case	Shield	Shield

Encoder Inputs: - Incremental: RS422
- Sin/Cos: 1Vpp

Maximal Input Frequency: 4.5 Mio. Incr./sec (incremental RS422), minimal pulsewidth > 220nsec
10kHz (analog 1Vpp), 10Bit AD

Sensor Supply: 5VDC (max. 100mA)

Sensor Alarm Input: 5V / 1mA

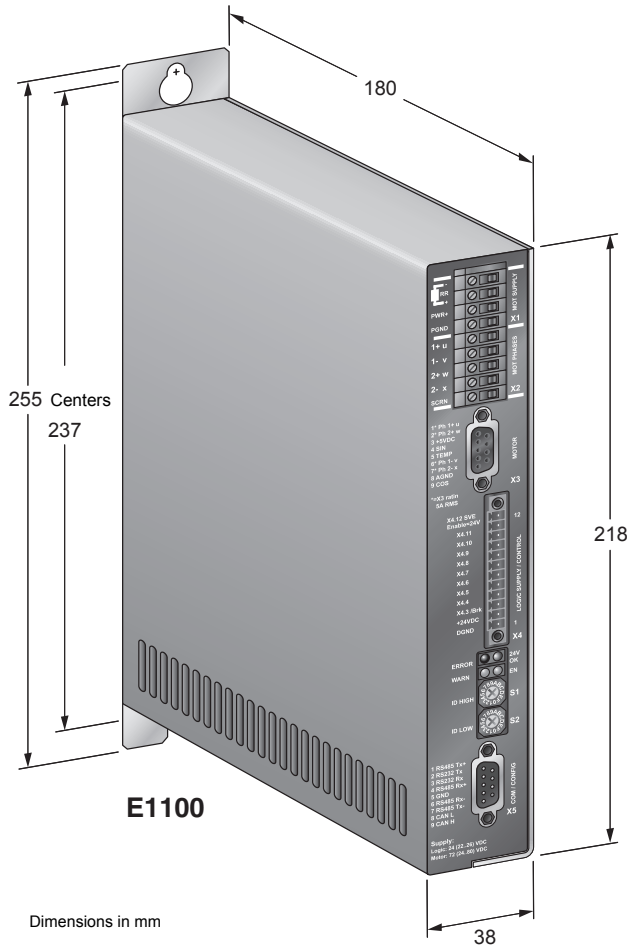

Servo Drives Series		E1100	
Width	mm (in)	38	(1.5)
Height	mm (in)	255	(10.0)
Height without fixings	mm (in)	218	(8.6)
Depth	mm (in)	180	(7.1)
Weight	kg (lb)	1.5	(3.3)
IP Protection class	IP	20	
Storage temperature	°C	-25...40	
Transport temperature	°C	-25...70	
Operating temperature	°C	0...40 at rated date	
		40...50 with power derating	
Max. case temperature	°C	65	
Max. power dissipation	W	30	
Min. distance between drives	mm (in)	20 (0.8)	left/right
		50 (2)	top/bottom

Artikel	Beschreibung	Artikelnummer
E1100-RS	RS232/485 Drive (72V/8A)	0150-1677
E1100-RS-HC	RS232/485 Drive (72V/15A)	0150-1678
E1100-RS-XC	RS232/485 Drive (72V/25A)	0150-1862
E1100-CO	CANopen Drive (72V/8A)	0150-1681
E1100-CO-HC	CANopen Drive (72V/15A)	0150-1682
E1100-CO-XC	CANopen Drive (72V/25A)	0150-1683
E1100-DN	DeviceNet Drive (72V/8A)	0150-1679
E1100-DN-HC	DeviceNet Drive (72V/15A)	0150-1680
E1100-DN-XC	DeviceNet Drive (72V/25A)	0150-1863
E1100-GP	General Purpose Drive (72V/8A)	0150-1665
E1100-GP-HC	General Purpose Drive (72V/15A)	0150-1666
E1100-GP-XC	General Purpose Drive (72V/25A)	0150-1864
E1130-DP	Profibus DP Drive, (72V/8A)	0150-1667
E1130-DP-HC	Profibus DP Drive, (72V/15A)	0150-1668
E1130-DP-XC	Profibus DP Drive, (72V/25A)	0150-1861

Switched-Mode Power Supplies

115VAC / 230VAC

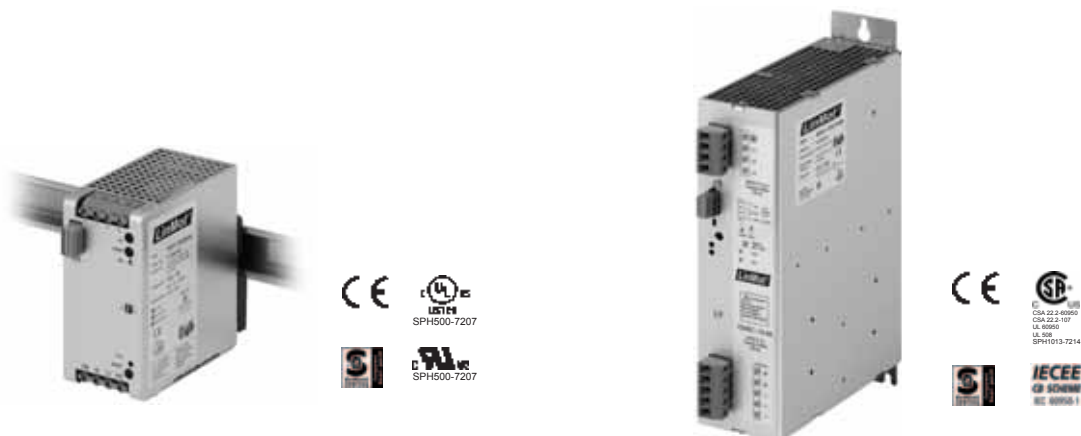

Item	Description	Part Number
S01-72/500	Switched-Mode Power Supply 72V/500W	0150-1874
S01-72/1000	Switched-Mode Power Supply 72V/1000W	0150-1872

Transformer Supply T01

3x230/280/400/480VAC



Item	Description	Part Number
T01-72/420...1500-Multi	Transformer Supply 3x230/280/400/480VAC, 50/60Hz, 420...1500W	see page 532

Control Box B01-E1100



Item	Description	Part Number
B01-E1100	Control Box for E1100 (incl. cable and connectors)	0150-1970

Connector Cable and USB-Converter



0150-3009

0150-3110

0150-3134

0150-2143

0150-1852

0150-1853

Item	Description	Part Number
RS232 PC config. cabel 2m	for E100/E1001	0150-3009
RS232 PC config. cabel 2m	for E100/E1001/E1100/B1100	0150-3307
RS232 PC config. cabel 2.5m	for E1200/E1400	0150-2143
USB-Serial Converter	USB to 9-pin Serial Converter	0150-3110
USB-CAN Converter	USB to CAN Converter for E1100	0150-3134
RJ45-08/0.3	RJ45 patch cable 0.3m for E1100	0150-1852
RJ45-08/0.6	RJ45 crossover patch cable 0.6m	0150-1853
RJ45/RJ45-0,2-ML1	MC-Link cable 0,2m	0150-3308

Option: External High Resolution Encoder



Item	Description	Part Number
MS01-1/D	Linear Encoder 1um, A/B (for 1mm magnetic band)	0150-1840
MB01-1000	Magnetic Band 1mm pitch, per cm	0150-1963