

Motor Cables 508

Motor Flanges 518

Slider Mounts 522

Wipers 524

External Position Sensor 526

Switched-Mode Power Supplies 528

Switched-Mode Power Supplies 72V 530

Transformer Supplies 532

Regeneration Resistor 534

Connector Cable and Converter 534

Control Box 535

Motor Accessories

An extensive array of accessories, tailored to LinMot P01 linear motors and compatible with the Servo Drives, rounds out the LinMot Drive Systems product range.



Motor Cable

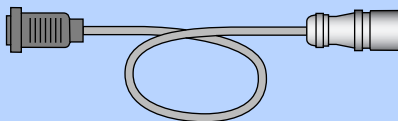

Pre-fabricated motor cables, or bulk stock in standard, high-flex, and robot versions.

Details Page 508

Motor Flanges

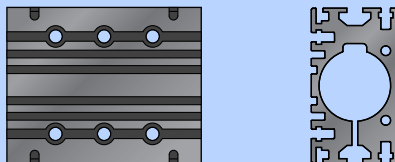

Motor flanges for mounting LinMot stators.

Details Page 518

Slider Mounting Kits

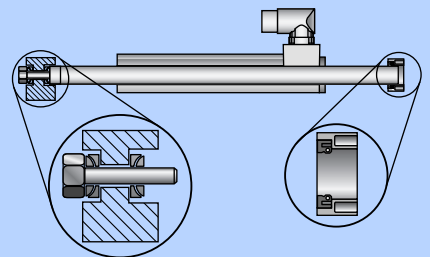

Slider mounting kits, for simple mounting of the slider in "moving slider" or "moving stator" applications.

Details Page 522

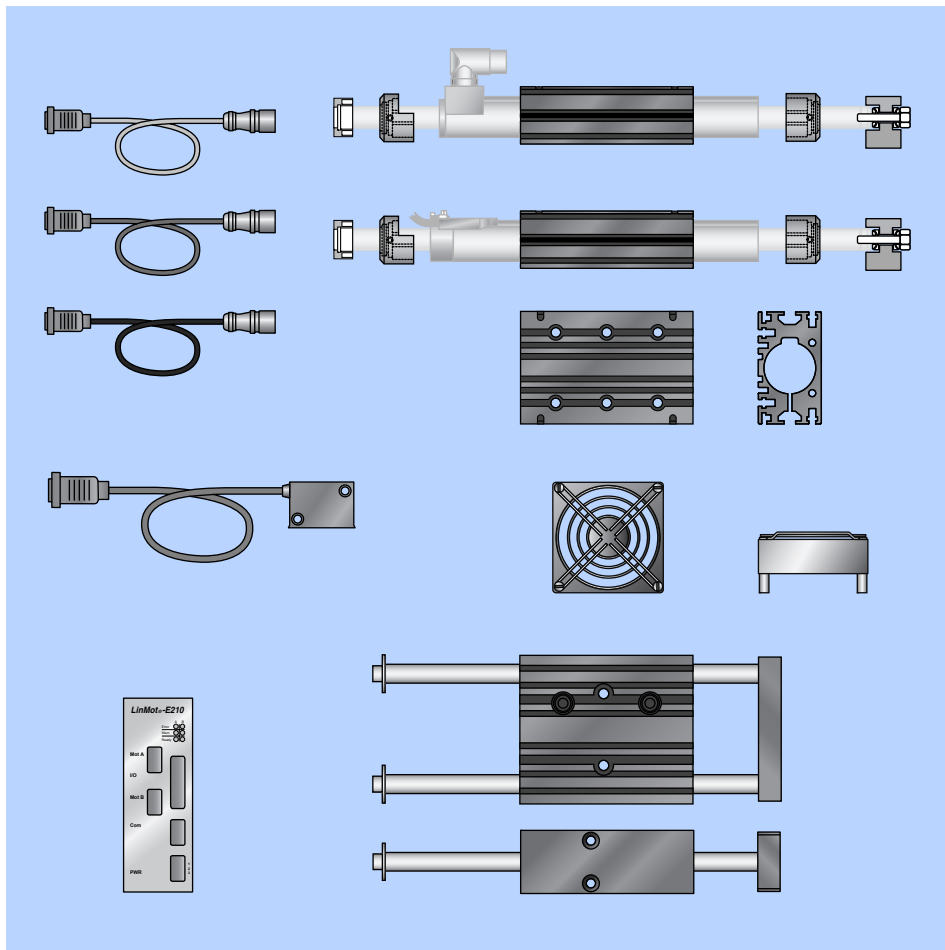

LinMot's array of accessories designed for linear motors allows quick, simple implementation and startup of various tasks. The original motor accessories, specially designed for LinMot, also ensure reliable and fault-free operation of the linear motors.

Option: Fan

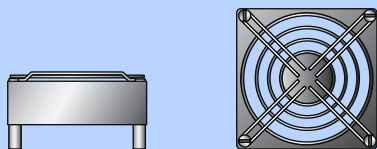

With an optional fan, the effective force of the linear motor can be nearly doubled.

Details Page 521

Option: Wipers

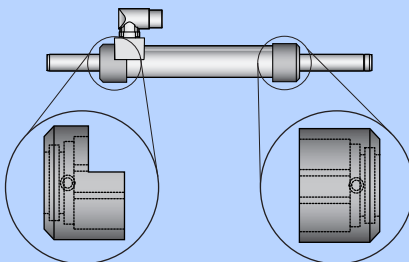

Wipers for use in difficult environments. The wipers keep the slider free of grease or contaminants, and protect the stator from dirt.

Details Page 524

Option: External Position Sensor

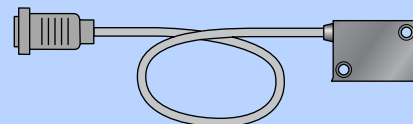

An external position sensor is available for high-precision applications with extreme requirements for positioning accuracy.

Details Page 526

Motor Cables

Motor cables are available for linear motors with the designation K, KS, and KR for stationary installation, installation in cable chains, and for robot applications.

LinMot motor cables are available in all three versions as bulk goods, as a roll, or as a completely fabricated motor cable with a wide range of plug combinations and any desired length. Standard lengths with the most common connector combinations are also available from stock.



Standard Motor Cable K

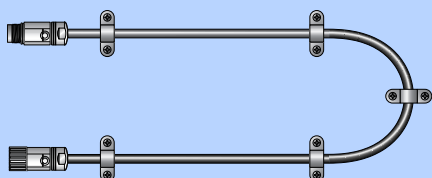

The standard motor cable, type K, is suitable for stationary runs. It is used wherever the motor cable is fixed and is not subject to motion. At exposed locations, the motor cable should be protected from mechanical damage by cable conduits.

High-Flex Motor Cable KS

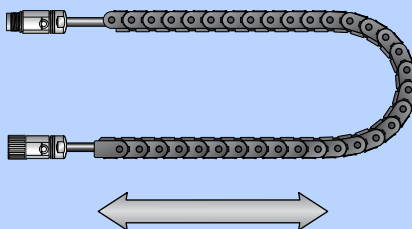

The high-flex motor cable, type KS, is suitable for applications with moving motor cables, where the cable is run inside a cable track, and is subject to roll-up motion. High-Flex cable is supplied without the cable track.

Robot Motor Cable KR

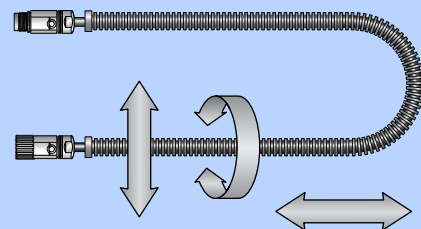

If the motor cable is subject to torsional motion, then the special robot cable, type KR, is used. In order to protect the robot cable from mechanical damage, it should be run in an appropriate cable conduit.

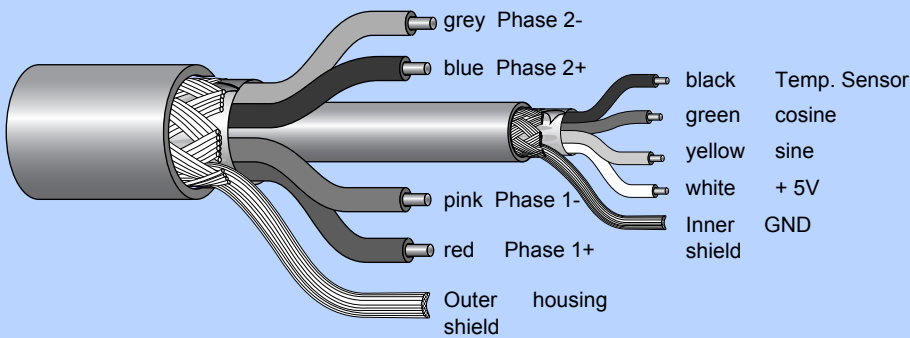

A single motor cable is sufficient to connect the linear motor and Servo Drive. It contains the motor phases and sensor signals from the position sensors integrated in the motor.

All LinMot motor cables have separate shielding for the motor phases and the sensor signals. This special double shielding ensures fault-free operation of linear motors at up to 50m cable lengths.

Flat Ribbon Cable KF

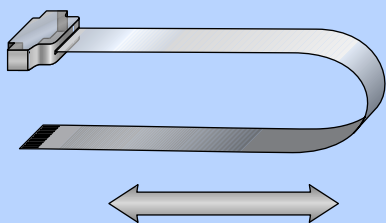

For the short motor P02-23Sx80, a flat ribbon cable is available with the designation KF. The flat ribbon cable can be subjected to roll-up motion, just as the high-flex cable. Due to its low level of predection, the flat ribbon cable is more suitable for device design than for machine building.

Motor Cable, Bulk Goods

LinMot motor cable is available by the meter in all versions, K, KS, and KR. The cable can be cut to the desired length, or ordered in large quantities on rolls.

LinMot provides all of its motor connectors for customer fabrication of motor cables. Motor cables fabricated by the customer are to be tested with a test voltage of 1500VDC prior to startup.

Fabricated Motor Cable

Fabricated motor cables can be provided with any desired length up to 50m. The motor cable is ordered in the desired length, together with the matching motor connectors (fabricated).

Fabricated motor cables with the most commonly used connector combinations can be ordered from stock in standard lengths.

Fabricated motor cables from LinMot are manufactured exclusively with crimped contacts, and tested under 1500VDC prior to delivery.

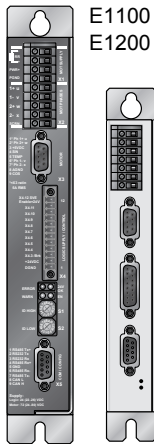

E1100
E1200

B1100
B1150
C1200

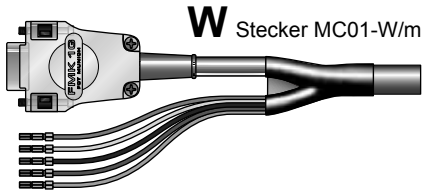

W Stecker MC01-W/m

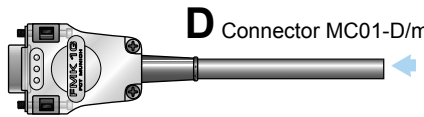

D Connector MC01-D/m

Only for stators with current within the drive's connector specification.

Standard cable K15-04/05

High flex cable KS10-04/05

Robot cable KR10-04/05



E1100: D-sub connector up to 5 A_{rms} / 7.5 A_{peak}
For UL, use W connectors only

B1100: D-sub connector up to 3 A_{rms} / 4.5 A_{peak}



E1001

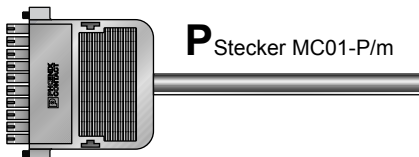

P Stecker MC01-P/m



Standard cable K05-04/05

High flex cable KS05-04/05

Robot cable KR05-04/05

- For the connection between the linear motor and Servo Drive, only the specially shielded LinMot cables of type K, KS or KR should be used.
- The length of the cable can be up to 50 m between the linear motor and the Servo Drive.
- Motor cables fabricated by the customer are to be tested with a test voltage of 1500VDC.
- An improperly fabricated motor cable can damage both the linear motor and the Servo Drive.
- The minimum bend radius is to be observed for stationary cables as well as for moving motor cables.
- The motor cable must not be plugged in or unplugged while under voltage.

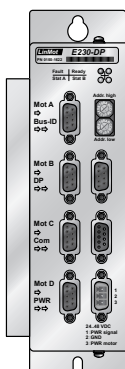

E100

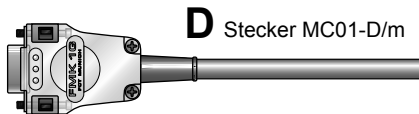

D Stecker MC01-D/m

Ordering Example:

4m high flex cable for Servo Drive E1100 and linear motor PS01-23x160-R:
- KS05-D/R-4

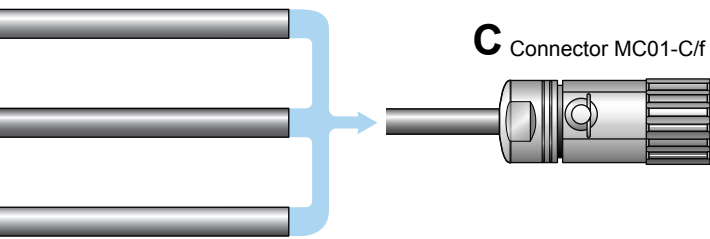

Connector Type		PS01-48X240-C PS01-48x240F-C
		PS01-37x240F-C
Cable Type		PS01-37X240F-C20

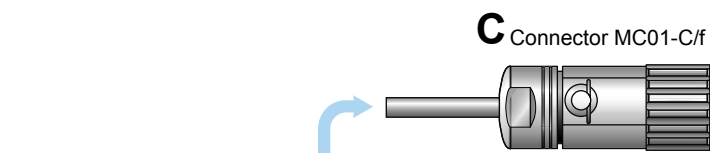

Connector Type		PS01-48X240-C PS01-48X240F-C
		PS01-37X240-C PS01-37X240F-C PS01-37x120-C PS01-37x120F-HP-C
Cable Type		PS01-37X240-C20 PS01-37X240F-C20 PS01-37X120-C20 PS01-37X120F-HP-C20

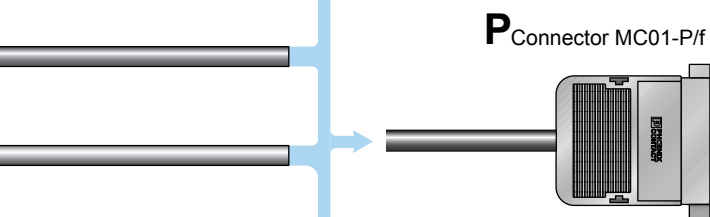

Cable Type		PS01-37x240 PS01-37X120
------------	--	----------------------------

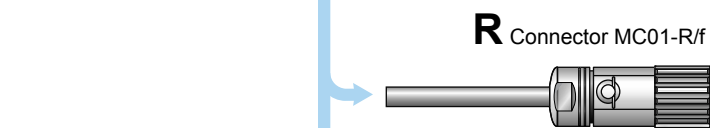

Connector Type		PS01-23x160-R PS01-23x160F-R PS01-23x160G-HP-R PS01-23x80-R
Cable Type		PS01-23x160-R20 PS01-23x160F-R20 PS01-23x160G-HP-R20 PS01-23x80-R20

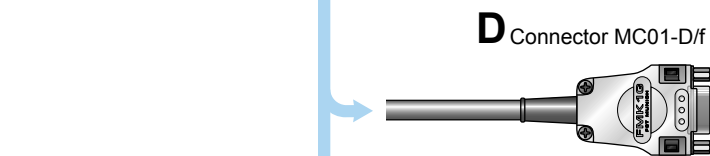

Cable Type		PS01-23x160 PS01-23x80
------------	--	---------------------------

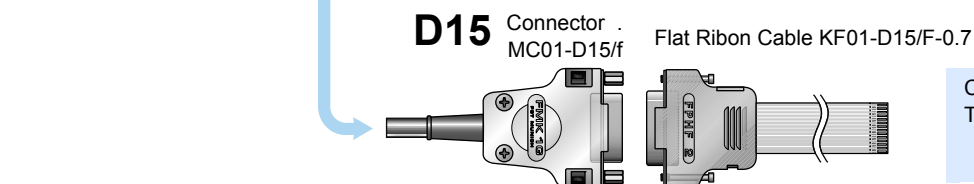

Cable Type		PS02-23Sx80
------------	--	-------------

Fabricated Motor Cables standard lengths

Item	Description	Part Number
MOTOR CABLE ASSEMBLED STANDARD		
K05-D/D-2	motor cable D/D, 2 m	0150-1910
K05-D/D-4	motor cable D/D, 4 m	0150-1911
K05-D/D-6	motor cable D/D, 6 m	0150-1912
K05-D/D-8	motor cable D/D, 8 m	0150-1913
K05-D/P-0.25	motor cable D/P, 0.25m	0150-1921
K05-D/P-2	motor cable D/P, 2 m	0150-1949
K05-D/P-4	motor cable D/P, 4 m	0150-1995
K05-D/P-6	motor cable D/P, 6 m	0150-1994
K05-D/R-2	motor cable D/R, 2 m	0150-1832
K05-D/R-4	motor cable D/R, 4 m	0150-1833
K05-D/R-6	motor cable D/R, 6 m	0150-1834
K05-D/R-8	motor cable D/R, 8 m	0150-1835
K05-D/C-2	motor cable D/C, 2 m	0150-1819
K05-D/C-4	motor cable D/C, 4 m	0150-1820
K05-D/C-6	motor cable D/C, 6 m	0150-1821
K05-D/C-8	motor cable D/C, 8 m	0150-1822
K05-P/D-0.4	motor cable P/D, 0.4 m	0150-1922
K05-P/P-2	motor cable P/P, 2 m	0150-1915
K05-P/P-4	motor cable P/P, 4 m	0150-1916
K05-P/P-6	motor cable P/P, 6 m	0150-1917
K05-P/P-8	motor cable P/P, 8 m	0150-1918
K05-P/C-2	motor cable P/C, 2 m	0150-1818
K05-P/C-4	motor cable P/C, 4 m	0150-1804
K05-P/C-6	motor cable P/C, 6 m	0150-1805
K05-P/C-8	motor cable P/C, 8 m	0150-1806
K05-W/R-2	motor cable W/R, 2 m	0150-2119
K05-W/R-4	motor cable W/R, 4 m	0150-2120
K05-W/R-6	motor cable W/R, 6 m	0150-2121
K05-W/R-8	motor cable W/R, 8 m	0150-2122
K05-W/C-2	motor cable W/C, 2 m	0150-2123
KS05-W/N-2	motor cable W/C, 2 m	0150-2296
KS05-W/N-4	motor cable W/C, 2 m	0150-2297
KS05-W/N-6	motor cable W/C, 2 m	0150-2298
KS05-W/N-8	motor cable W/C, 2 m	0150-2299
K05-W/C-4	motor cable W/C, 4 m	0150-2124
K05-W/C-6	motor cable W/C, 6 m	0150-2125
K05-W/C-8	motor cable W/C, 8 m	0150-2126
K05-W/D-0.4	motor cable W/D, 0.4 m	0150-1947
K05-W/P-0.4	motor cable W/P, 0.4 m	0150-1948
K15-W/C-2	motor cable W/C, 2 m	0150-1811
K15-W/C-4	motor cable W/C, 4 m	0150-1801
K15-W/C-5	motor cable W/C, 5 m	0150-1849
K15-W/C-6	motor cable W/C, 6 m	0150-1802
K15-W/C-8	motor cable W/C, 8 m	0150-1803
MOTOR CABLE ASSEMBLED HIGH FLEX		
KS05-D/D-2	trailing chain cable D/D, 2 m	0150-1988
KS05-D/D-4	trailing chain cable D/D, 4 m	0150-1989
KS05-D/R-2	trailing chain cable D/R, 2 m	0150-1854
KS05-D/R-4	trailing chain cable D/R, 4 m	0150-1836
KS05-D/R-6	trailing chain cable D/R, 6 m	0150-1855
KS05-D/R-8	trailing chain cable D/R, 8 m	0150-1837
KS05-D/C-2	trailing chain cable D/C, 2m	0150-1856
KS05-D/C-4	trailing chain cable D/C, 4 m	0150-1823
KS05-D/C-6	trailing chain cable D/C, 6 m	0150-1857
KS05-D/C-8	trailing chain cable D/C, 8 m	0150-1824
KS05-P/P-2	trailing chain cable P/P, 2 m	0150-1990
KS05-P/P-4	trailing chain cable P/P, 4 m	0150-1991
KS05-P/C-4	trailing chain cable P/C, 4 m	0150-1809
KS05-P/C-8	trailing chain cable P/C, 8 m	0150-1810
KS05-R/R-2	trailing chain cable R/R, 2 m	0150-1838
KS05-R/R-4	trailing chain cable R/R, 4 m	0150-1839
KS05-W/C-4	trailing chain cable W/C, 4 m	0150-2127
KS05-W/C-6	trailing chain cable W/C, 6 m	0150-2128
KS05-W/C-8	trailing chain cable W/C, 8 m	0150-2129
KS05-W/R-4	trailing chain cable W/R, 4 m	0150-2106
KS05-W/R-6	trailing chain cable W/R, 6 m	0150-2131
KS05-W/R-8	trailing chain cable W/R, 8 m	0150-2107
KS05-C/C-2	trailing chain cable C/C, 2 m	0150-1827
KS05-C/C-4	trailing chain cable C/C, 4 m	0150-1828
KS10-C/C-2	trailing chain cable C/C, 2 m	0150-1816
KS10-C/C-4	trailing chain cable C/C, 4 m	0150-1817
KS10-W/C-4	trailing chain cable W/C, 4 m	0150-1807
KS10-W/C-5	trailing chain cable W/C, 5 m	0150-1860
KS10-W/C-6	trailing chain cable W/C, 6 m	0150-1858
KS10-W/C-8	trailing chain cable W/C, 8 m	0150-1808
POWER & ENCODER CABLE FOR LINEAR MOTORS P10-70 (3x400...480VAC)		
KPS15-04-L/Q-3	power trailing chain cable L/Q, 3m	0150-2266
KPS15-04-L/Q-5	power trailing chain cable L/Q, 5m	0150-2261
KPS15-04-L/Q-8	power trailing chain cable L/Q, 8m	0150-2267
KPS15-04-L/Q-12	power trailing chain cable L/Q, 12m	0150-2268
KSS05-02/08-D15/J-3	encoder trailing chain cable D15/J, 3m	0150-2263
KSS05-02/08-D15/J-5	encoder trailing chain cable D15/J, 5m	0150-2262
KSS05-02/08-D15/J-8	encoder trailing chain cable D15/J, 8m	0150-2264
KSS05-02/08-D15/J-12	encoder trailing chain cable D15/J, 12m	0150-2265

Motor Cable and Connectors

Item	Description	Part Number
MOTOR CABLE PER M		
K05-04/05	motor cable per m	0150-1920
K05-04/05-50	motor cable 50m roll	0150-1956
K05-04/05-100	motor cable 100m roll	0150-1957
K05-04/05-200	motor cable 200m roll	0150-1958
K15-04/05	motor cable per m	0150-1978
K15-04/05-100	motor cable, 100 m roll	0150-1969
KS03-09	trailing chain cable per m (max. 2m)	0150-2182
KS05-04/05	trailing chain cable (per m)	0150-1938
KS05-04/05-100	trailing chain cable 100 m roll	0150-1959
KS10-04/05	trailing chain cable per m	0150-1977
KS10-04/05-100	trailing chain cable, 100m roll	0150-1968
KR05-04/05	robotic cable (per m)	0150-1846
KR05-04/05-100	robotic cable, 100m roll	0150-1847
KR10-04/05	robotic cable (per m)	0150-1830
KR10-04/05-100	robotic cable, 100m roll	0150-1831
MOTOR CONECTORS, ASSEMBLED CONECTORS		
MC01-D/m	motor connector D (m)	0150-3024
MC01-D/f	motor connector D (f)	0150-3025
MC01-D15/f	motor connector D15/f	0150-3136
MC01-K/f	motor connector K (f)	0150-3345
MC01-P/m	motor connector P (m)	0150-3020
MC01-P/f	motor connector P(f)	0150-3021
MC01-R/m	motor connector R/m	0150-3130
MC01-R/f	motor connector R/f	0150-3129
MC01-N/f	motor connector N/f	0150-3407
MC01-C/m	motor connector C/m	0150-3093
MC01-C/f	motor connector C/f	0150-3080
MC01-W/m	motor connector W/m	0150-3140
MC01-D/m-as	D/m-connector assembled	0150-3055
MC01-D/f-as	D/f-connector assembled	0150-3142
MC01-D15/m-as	D15/m-connector assembled	0150-3148
MC01-D15/f-as	D15/f-connector assembled	0150-3073
MC01-K/f-as	K/f-connector assembled	0150-3346
MC01-P/m-as	P/m-connector assembled	0150-3056
MC01-P/f-as	P/f-connector assembled	0150-3144
MC01-R/m-as	R/m-connector assembled	0150-3097
MC01-R/f-as	R/f-connector assembled	0150-3143
MC01-N/f-as	N/f-connector assembled	0150-3408
MC01-C/m-as	C/m-connector assembled	0150-3099
MC01-C/f-as	C/f-connector assembled	0150-3146
MC01-W/m-as	W/m-connector assembled	0150-3147
MOTOR CONECTORS IP69K, ASSEMBLED CONECTORS IP69K		
MC01-R/f-IP69K	motor connector R/f, IP69K	0150-3341
MC01-R/f-IP69K-SSC	motor connector R/f, IP69K, SSC	0150-3347
MC01-C/f-IP69K	motor connector C/f, IP69K	0150-3339
MC01-C/f-IP69K-SSC	motor connector C/f, IP69K, SSC	0150-3306
MC01-R/f-IP69K-as	motor connector R/f, IP69K, assembled	0150-3342
MC01-R/f-IP69K-SSC-as	motor connector R/f, IP69K, SSC, assembled	0150-3343
MC01-C/f-IP69K-as	motor connector C/f, IP69K, assembled	0150-3340
MC01-C/f-IP69K-SSC-as	motor connector C/f, IP69K, SSC, assembled	0150-3325
MOTOR CABLE FOR SHORT MOTOR P02-23Sx80-F		
KF02-D15/F-0.70	flat cable 0.7m, for PS02-23Sx80-F	0150-2158
KF02-D15/F-0.48	flat cable 0.48m, for PS02-23Sx80-F	0150-2154
KF02-D15/F-0.32	flat cable 0.32m, for PS02-23Sx80-F	0150-2152
KF02-D15/F-0.16	flat cable 0.16m, for PS02-23Sx80-F	0150-2156
KF02-D15/F-0.08	flat cable 0.08m, for PS02-23Sx80-F	0150-2150
K05-D/D15-1	adapter cable D/D15, 1m (for PS02-23Sx80)	0150-1936
MOTOR CABLE FOR SHORT MOTOR P02-23Sx80F-HP-K		
KS03-W/K-2	trailing chain cable W/K 2m	0150-2187
KS03-R/K-1	trailing chain cable R/K 1m	0150-2185
KS03-R/K-2	trailing chain cable R/K 2m	0150-2186
CABLE AND CONNECTORS FOR LINEAR MOTORS P10-70 (3x400...480VAC)		
KPS15-04	trailing chain cable power (per m)	0150-2257
KSS05-02/08	trailing chain cable encoder (per m)	0150-2258
MC10-L/m	Drive connector power MC10-L/m	0150-3382
MC10-Q/m	Motor connector Q/m	0160-2405
MC10-Q/f	Motor connector MC10-Q/f	0160-2268
MC10-D15-45°/f	Drive connector encoder D15-45°/f	0150-3397
MC10-J/m	Motor connector encoder MC10-J17/m	0160-2407
MC10-J/f	Motor connector encoder MC10-J/f	0160-2269
MC10-L/m-as	Connector L/m assembled	0160-2330
MC10-Q/m-as	Connector Q/m assembled	0160-2406
MC10-Q/f-as	Connector Q/f assembled	0160-2329
MC10-D15-45°/f-as	Connector D15-45°(f) assembled	0150-3399
MC10-J/m-as	Connector J/m assembled	0160-2408
MC10-J/f-as	Connector J/f assembled	0160-2331

R-Connector

MC01-R/m

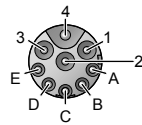
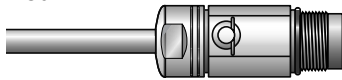

MC01-R/f

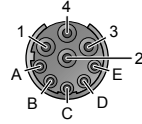
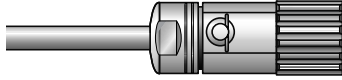

1	Phase 1+	red
2	Phase 1-	pink
3	Phase 2+	blue
4	Phase 2-	grey
A	+5V	white
B	GND	inner shield
C	Sensor sine	yellow
D	Sensor cosine	green
E	Temp. Sensor	black
housing	shield	outer shield

MC01-F/R

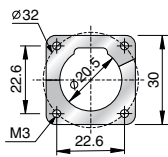

Mounting-window:

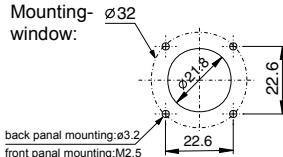

Item	Part Number
MC01-R/m	0150-3130
MC01-R/f	0150-3129
MC01-R/m-as (assembled)	0150-3097
MC01-R/f -as (assembled)	0150-3143
MC01-F/R Connector Flange	0150-3253
MC01-R/m-cap	0150-3376
MC01-R/f-cap	0150-3377

MC01-R/m-cap



MC01-R/m-cap



C-Connector

MC01-C/m

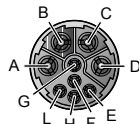

MC01-C/f

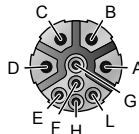
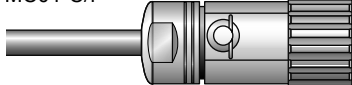

A	Phase 1+	red
B	Phase 1-	pink
C	Phase 2+	blue
D	Phase 2-	grey
E	+5V	white
F	GND	inner shield
G	Sensor sine	yellow
H	Sensor cosine	green
L	Temp. Sensor	black
housing	shield	outer shield

MC01-F/C

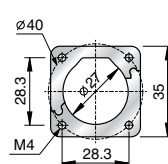

Mounting-window:

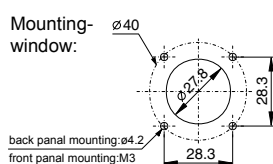

Item	Part Number
MC01-C/m	0150-3093
MC01-C/f	0150-3080
MC01-C/m-as (assembled)	0150-3099
MC01-C/f-as (assembled)	0150-3146
MC01-F/C Connector Flange	0150-3254
MC01-C/m-cap	0150-3378
MC01-C/f-cap	0150-3379

MC01-C/m-cap



MC01-C/m-cap



W-Connector

MC01-W/m

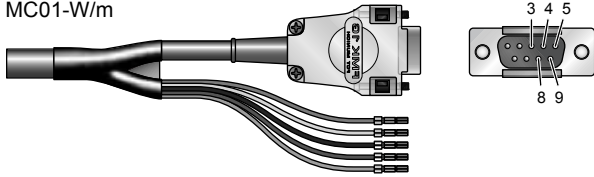

strand red	Phase 1+	red
strand pink	Phase 1-	pink
strand blue	Phase 2+	blue
strand grey	Phase 2-	grey
3	+5V	white
8	GND	inner shield
4	Sensor sine	yellow
9	Sensor cosine	green
5	Temp. Sensor	black
shield	shield	outer shield

Item	Part Number
MC01-W/m	0150-3140
MC01-W/m-as (assembled)	0150-3147

D-Connector

MC01-D/m

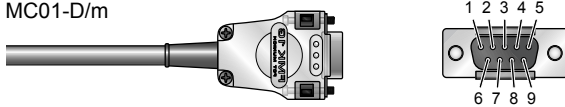

1	Phase 1+	red
6	Phase 1-	pink
2	Phase 2+	blue
7	Phase 2-	grey
3	+5V	white
8	GND	inner shield
4	Sensor sine	yellow
9	Sensor cosine	green
5	Temp. Sensor	black
housing	shield	outer shield

Item	Part Number
MC01-D/m	0150-3024
MC01-D/f	0150-3025
MC01-D/m-as (assembled)	0150-3055
MC01-D/f-as (assembled)	0150-3142

MC01-D/f

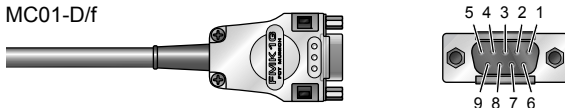

P-Connector

MC01-P/m

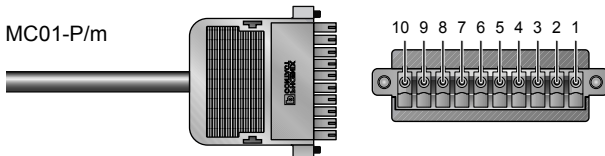

1	Phase 1+	red
2	Phase 1-	pink
3	Phase 2+	blue
4	Phase 2-	grey
5	+5V	white
6	GND	inner shield
7	Sensor sine	yellow
8	Sensor cosine	green
9	Temp. Sensor	black
10	shield	outer shield

Item	Part Number
MC01-P/m	0150-3020
MC01-P/f	0150-3021
MC01-P/m-as (assembled)	0150-3056
MC01-P/f-as (assembled)	0150-3144

MC01-P/f

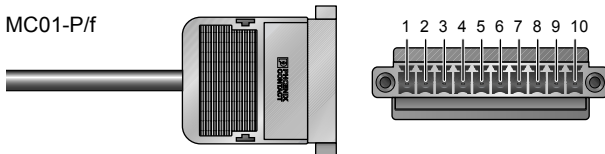

Shrink tubing for IP67 connectors

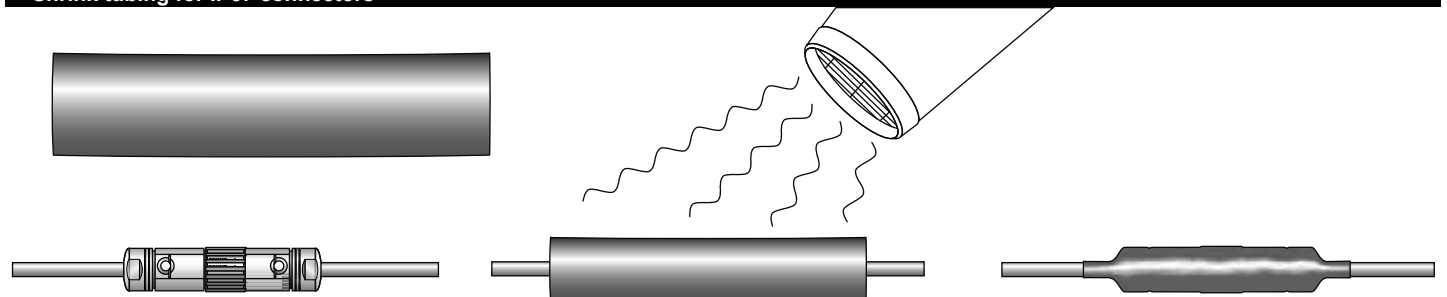

Item	Material	Part Number
MCP01-18 Shrink tubing (with hot glue coating) for additional protection of IP67 connectors	Polyolefin	0150-3089

K-Connector

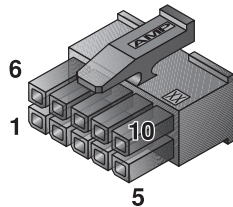
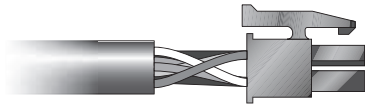

1	red	Phase 1+
2	blue	Phase 2+
4	rose	Phase 1-
5	grey	Phase 2-
6	yellow	Sensor sine
7	green	Sensor cosine
8	brown	GND
9	white	+5V
10	black	Temp. Sensor
housing	shield	outer shield

Item	Part Number
MC01-K/f	0150-3345
MC01-K/f-as (assembled)	0150-3346

N-Connector

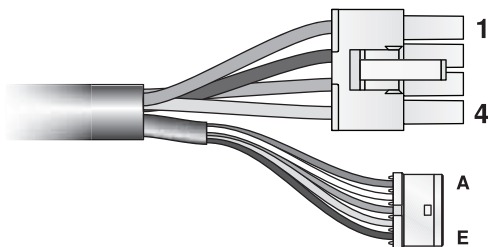

1	red	Phase 1+
2	rose	Phase 1-
3	blue	Phase 2+
4	grey	Phase 2-
A	white	+5V
B	inner shield	GND
C	yellow	Sensor sine
D	green	Sensor cosine
E	black	Temp sensor
housing	outer shield	housing

Item	Part Number
MC01-N/f	0150-3407
MC01-N/f-as (assembled)	0150-3408

F-Connector

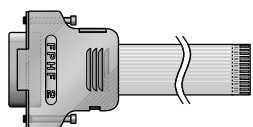

MC01-D15W/f

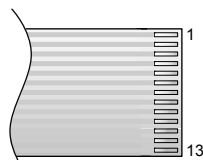

ZIF-Line Molex
pitch 1.25mm



Plugging in or unplugging the flat ribbon cable under voltage can damage the motor and drive.

12 & 13	Phase 2-	12 & 13
3 & 4	Phase 2+	3 & 4
10 & 11	Phase 1-	10 & 11
1 & 2	Phase 1+	1 & 2
5	Sensor sine	5
7	GND	7
9	+5V	9
8	Temp. Sensor	8
6	Sensor cosine	6

Item	Part Number
KF02-D15/F-...	see Page 513

Flat ribbon cable with D15/m-Connector

D15-Connector

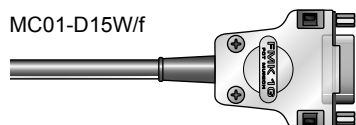

MC01-D15W/f

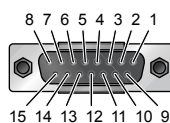

7 & 15	Phase 1+	red
3 & 10	Phase 1-	pink
6 & 14	Phase 2+	blue
2 & 9	Phase 2-	grey
11	+5V	white
12	GND	inner shield
13	Sensor sine	yellow
5	Sensor cosine	green
4	Temp. Sensor	black
housing	shield	outer shield

Item	Part Number
MC01-D15/f	0150-3136
MC01-D15/f-as (assembled)	0150-3073

LinMot Cable

	Standard cable		High Flex cable		Robot cable		Flat ribbon cable
Cable Type	K05-04/05	K15-04/05	KS05-04/05	KS10-04/05	KR05-04/05	KR10-04/05	KF02-D15/F-...
Diameter	0.5mm ²	1.5mm ²	0.5mm ²	1.0mm ²	0.5mm ²	1.0mm ²	
Motor phases	(AWG20)	(AWG16)	(AWG20)	(AWG18)	(AWG20)	(AWG18)	
Diameter		0.14mm ²		0.14mm ²		0.14mm ²	
Sensor signals		(AWG26)		(AWG26)		(AWG26)	
Inner isolation material	TPE-U		TPE-E		TPE-E		Polyester
Outer isolation material	PUR		PUR		PUR		
Cable color	black		black		black		white
Cable diameter	8.2mm (0.31in)	11.2mm (0.44in)	9.5mm (0.38in)	10.8mm (0.42in)	9.7mm (0.38in)	10.9mm (0.43in)	17.8x0.2mm (0.7x0.008in)
Weight	83kg/km	180kg/km	113kg/km	139kg/km	109kg/km	136kg/km	
Approvals	Materials according UL		UL / CSA 300V		UL / CSA 300V		
Minimal bending radius fix installed	25mm (1in)	50mm (2in)	30mm (1.2in)	50mm (2in)	30mm (1.2in)	50mm (2in)	foldable
Minimal bending radius moving	do not use in applications with moving motor cable		60mm (2.4in) no torsion	100mm (4in) no torsion	60mm (2.4in) Maximal torsion: ±270° per 0.5m	100mm (4in) Maximal torsion: ±270° per 0.5m	25mm
Temperature range	-40°...+80°C		-40°...+80°C		-40°...+80°C		-55°...+105°C
Available lengths	cable per m cable on rolls 50m, 100m, 200m		cable per m cable on rolls 100m		cable per m cable on rolls 100m		0.08-0.7m

Ordering information

	Standard cable		High-Flex cable		Robot cable		Flat ribbon cable
	0.5mm ²	1.5mm ²	0.5mm ²	1.0mm ²	0.5mm ²	1.0mm ²	
Cable per m	K05-04/05	K15-04/05	KS05-04/05	KS10-04/05	KR05-04/05	KR10-04/05	
	0150-1920	0150-1978	0150-1938	0150-1977	0150-1846	0150-1830	
Rolls 50m	K05-04/05-50						
	0150-1956						
Rolls 100m	K05-04/05-100	K15-04/05-100	KS05-04/05-100	KS10-04/05-100	KR05-04/05-100	KR10-04/05-100	
	0150-1957	0150-1969	0150-1959	0150-1968	0150-1847	0150-1831	
Rolls 200m	K05-04/05-200						
	0150-1958						
Single cable							KF02-D15/F-...

Motor Flanges

LinMot PF motor flanges allow simple and rapid mounting of LinMot P linear motors. The clamp plate design allows rapid and simple mounting/dismounting of linear motors, without removing the flange from the motor.

An appropriate flange, with the correct length, is available for each linear motor family. This not only ensures secure mechanical mounting, but also guarantees optimal cooling of the linear motor.

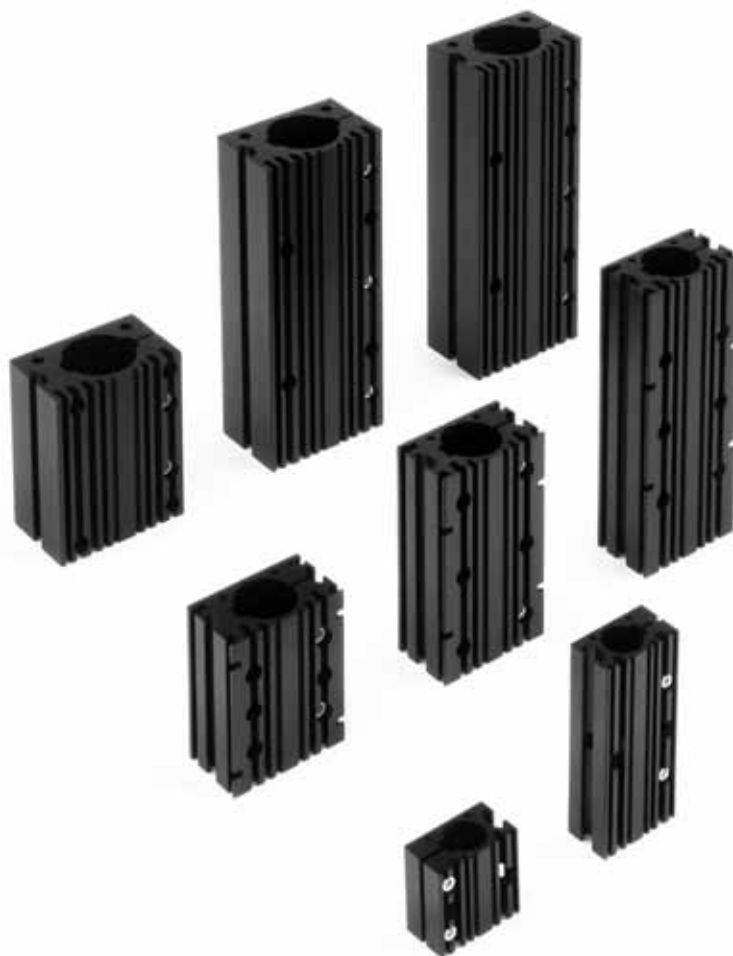

Stator Mounting

The same flange is used for stators with cable exits or connector housings. The stator is secured in the flange with clamping screws, so that the stator is clamped over a large area.

When the stator is mounted, the maximum screw torque should be observed and not exceeded.

Clamping over a large area, practically across the entire length of the stator, as well as the cooling fins on the flange, ensure optimal cooling of the linear motor.

Flange Mount Option

Depending on the application and installation space, the flanges can be mounted horizontally or vertically.

For horizontal installation, the flange is secured using screws in the through holes.

For vertical mounting, it is attached with T-nuts, using the T-slot on the narrow side of the flange.

Additional T-slots on the upper side of the flange allow accessories to be mounted easily.

Optional Fan

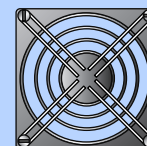
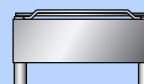

With an optional fan, the effective force of the linear motor can be nearly doubled.

Mounting with Screwholes

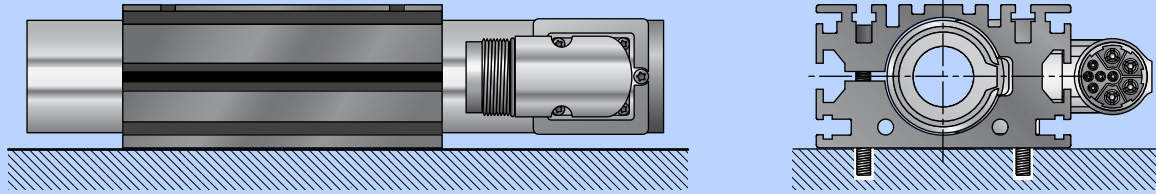

Mounting with T-Nut

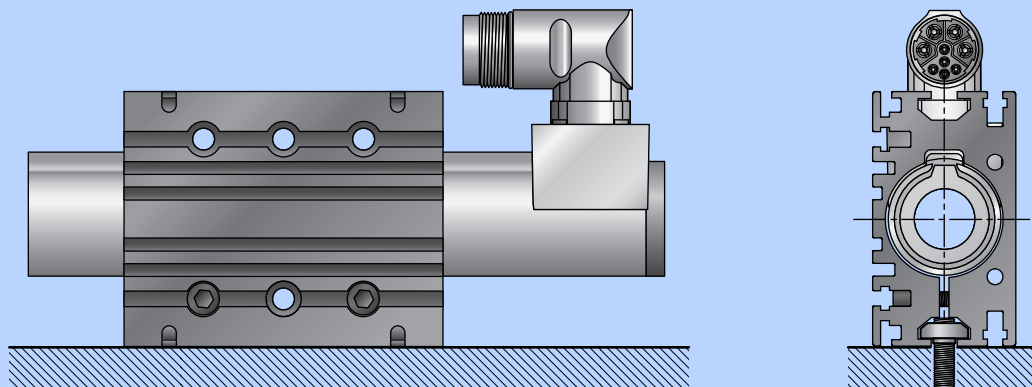

Ordering information

Item	Description	Part Number
PF02-23x50	Flange for Linear Motors P01-23x80	0150-2102
PF02-23x120	Flange for Linear Motors P01-23x160	0150-2103
PF02-23x170	Flange for Linear Motors P01-23x160	0150-2117
PF02-37x100	Flange for Linear Motors P01-37x120	0150-1998
PF02-37x140	Flange for Linear Motors P01-37x120	0150-2105
PF02-37x200	Flange for Linear Motors P01-37x240	0150-1999
PF01-48x120	Flange for Linear Motors P01-48x240	0150-1976
PF01-48x226	Flange for Linear Motors P01-48x240	0150-2108
PF01-48x346	Flange for Linear Motors P01-48x360	0150-2145

PF02-23

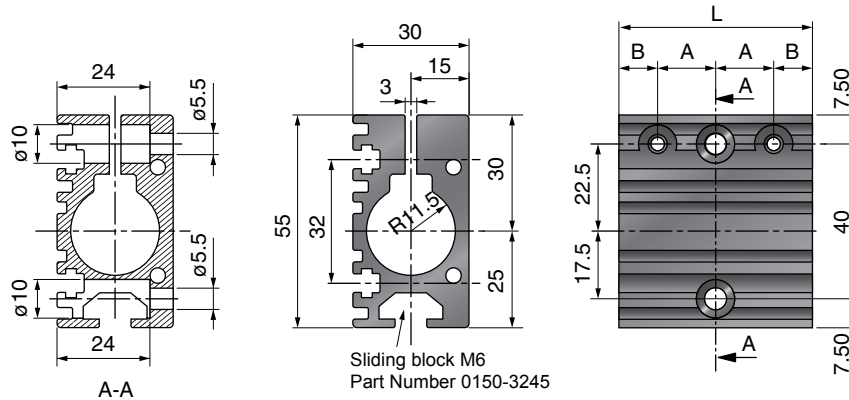

Max. torque for clamp plate screws: 4Nm

Sliding block M6
Part Number 0150-3245

Item	Description	L [mm]	A [mm]	B [mm]	Weight [g]	Part Number
PF02-23x50	Flange 23x50 mm	50	15	10	115	0150-2102
PF02-23x120	Flange 23x120 mm	120	30	30	280	0150-2103
PF02-23x170	Flange 23x170 mm	170	45	40	390	0150-2117

PF02-37

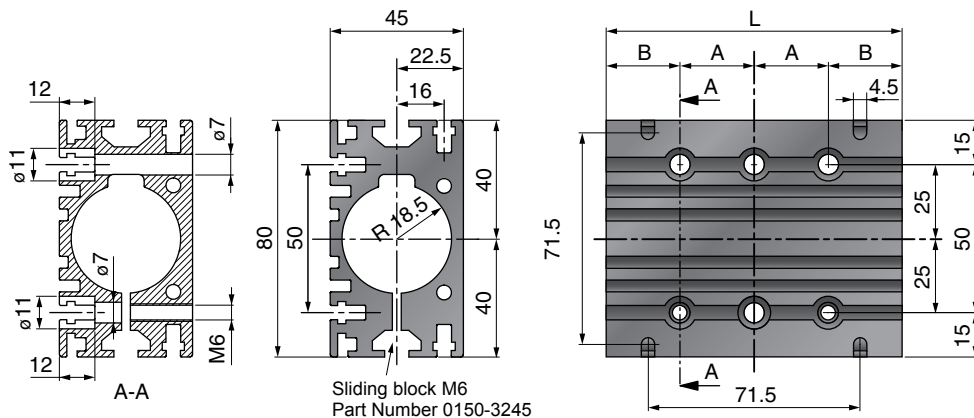

Max. torque for clamp plate screws: 8Nm

Sliding block M6
Part Number 0150-3245

Item	Description	L [mm]	A [mm]	B [mm]	Weight [g]	Part Number
PF02-37x100	Flange 37x100 mm	100	25	25	450	0150-1998
PF02-37x140	Flange 37x140 mm	140	50	20	630	0150-2105
PF02-37x200	Flange 37x200 mm	200	50	50	920	0150-1999

PF01-48

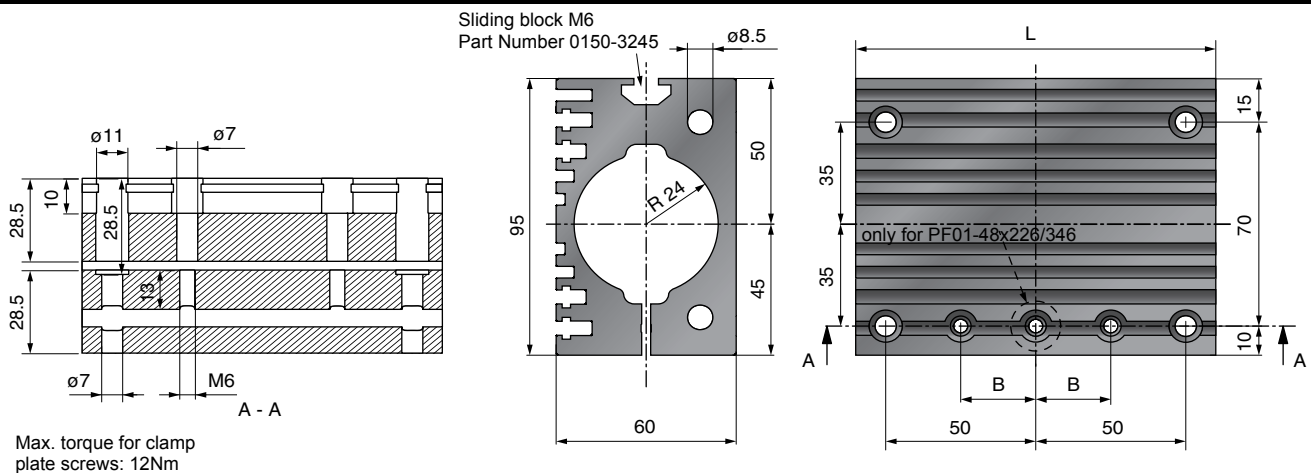

Max. torque for clamp plate screws: 12Nm

Sliding block M6
Part Number 0150-3245

Item	Description	L [mm]	B [mm]	Weight [g]	Part Number
PF01-48x120	Flange 48x120 mm	120	25	970	0150-1976
PF01-48x226	Flange 48x226 mm	226	85	1850	0150-2108
PF01-48x346	Flange 48x346 mm	346	100*	2650	0150-2145

*Details see p. 189

Optional Fan for PF02-23

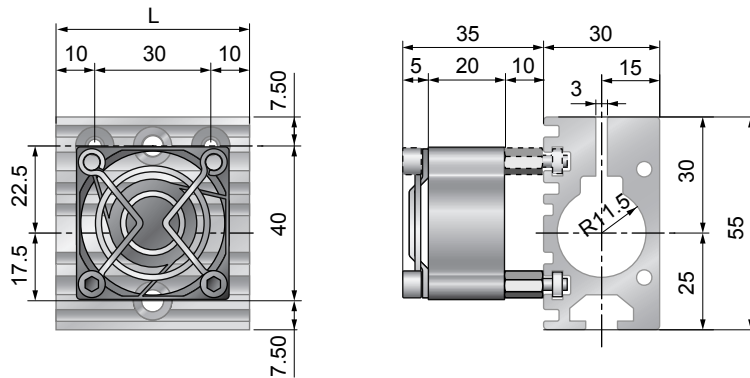

Fan supply:
24VDC, 70mA

Air flow:
15m³/h

Item	Description	Part Number
HV01-23	Fan kit for H01-23 and PF02-23	0150-5050

Optional Fan for PF02-37

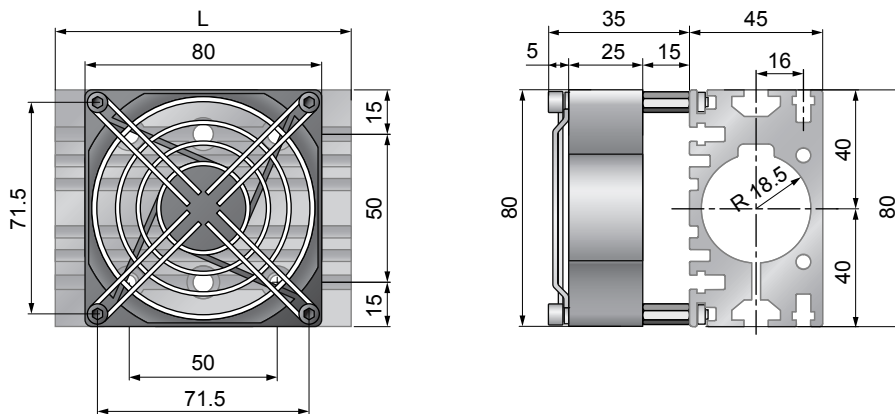

Fan supply:
24VDC, 120mA

Air flow:
80m³/h

Item	Description	Part Number
HV01-37/48	Fan kit for H01-37, B01-37 and PF02-37	0150-5051

Optional Fan for PF01-48

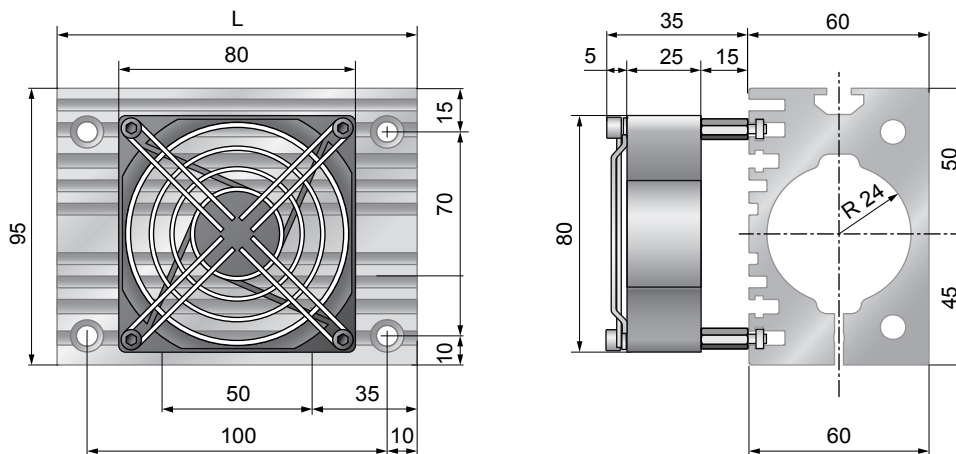

Fan supply:
24VDC, 120mA

Air flow:
80m³/h

Item	Description	Part Number
HV01-37/48	Fan kit for H01-48, B01-48 and PF01-48	0150-5051

Slider Mounts

Depending on the application, LinMot linear motors can be operated with a "moving slider" or "moving stator." Applications with short stroke ranges are preferably implemented with moving sliders; applications with long strokes are better with a moving stator. In both cases, LinMot recommends the use of special mounting kits for mounting the slider, in order to avoid overdetermining the mount.

In moving slider applications, the stator is mounted, and the slider is connected to a load that is guided by a linear guide. In order to avoid alignment errors, the slider is attached to the load or guide using fixed bearings, each consisting of two rounded washers and two bevel washers.

In moving stator applications, the slider is mounted and the stator is attached to a linear guide, together with the load. In order to avoid overdetermining the slider bearing, one end of the slider is mounted on a fixed bearing, and the other on a floating bearing.

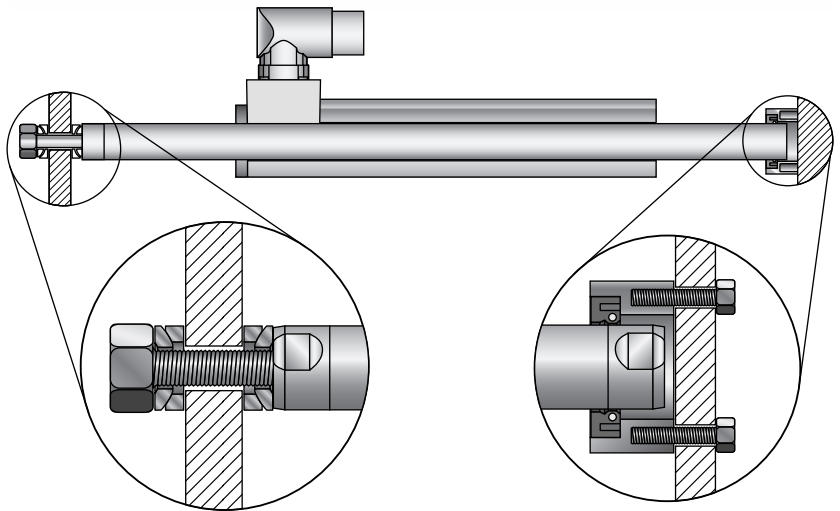

Fixed bearing

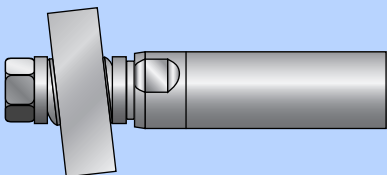

The fixed bearing consists of two rounded washers and two bevel washers. It compensates for angular and axial deflection.

Floating bearing

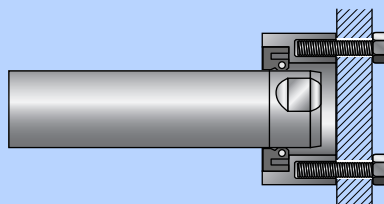

The slider is mounted in a rubber ring as a floating bearing. The floating bearing compensates for angular and axial displacement and length tolerance.

Material



Rounded and bevel washers:
Case-hardened steel



Bearing:
NBR
(Nitrile-Butadiene-Rubber with
DIN17223 spring steel)



Housing:
Stainless steel 1.4305

Moving Slider

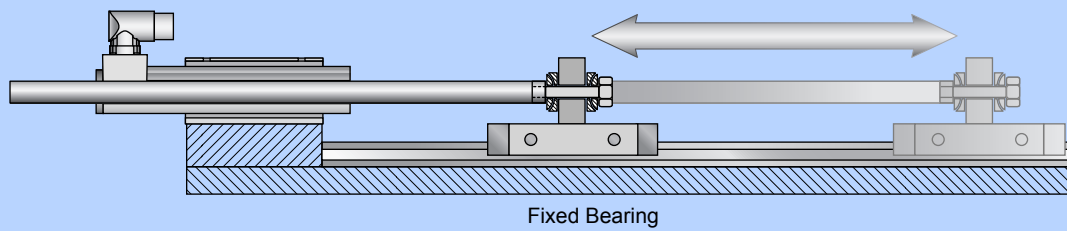

Moving Stator

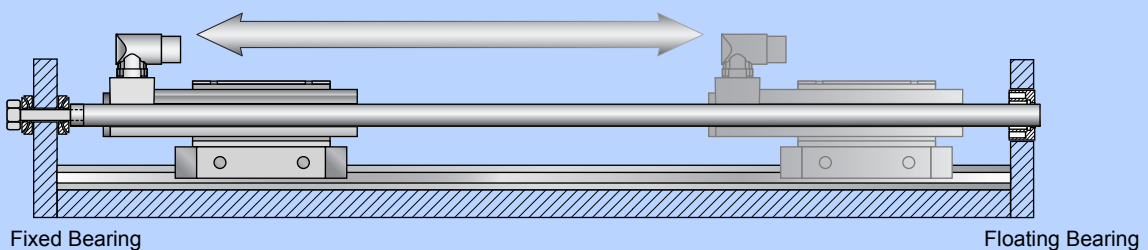

Dimensions and ordering information

Fix Bearing



DIN 6319 C

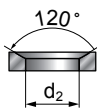

DIN 6319 D

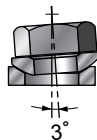
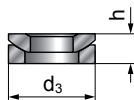

Item	Slider	Lead	d1	d2	d3	h
PLF01-12	12mm	M5	5.2mm (0.20in)	6.0mm (0.24in)	10.5mm (0.41in)	3.2mm (0.13in)
PLF01-20	20mm	M8	8.4mm (0.33in)	9.6mm (0.38in)	17mm (0.67in)	5.5mm (0.22in)
PLF01-28	28mm	M10	10.5mm (0.41in)	12mm (0.47in)	21mm (0.83in)	6.5mm (0.26in)

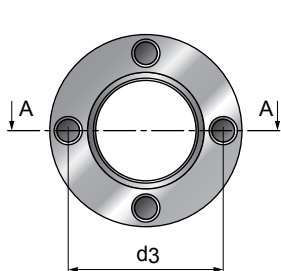

Floating Bearing

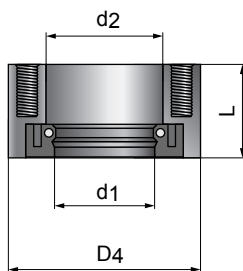

A-A

Item	Slider	Lead	d1	d2	d3	D4	L
PLL02-12	12mm	-	12mm (0.47in)	Gummi-ring	-	22mm (0.87in)	6.6mm (0.26in)
PLL01-19	19mm	M5	20mm (0.79in)	23mm (0.90in)	30mm (1.18in)	37mm (1.46in)	20mm (0.79in)
PLL01-20	20mm	M5	20mm (0.79in)	23mm (0.90in)	30mm (1.18in)	37mm (1.46in)	20mm (0.79in)
PLL01-27	27mm	M5	28mm (1.10in)	32mm (1.26in)	40mm (1.57in)	48mm (1.89in)	20mm (0.79in)
PLL01-28	28mm	M5	28mm (1.10in)	32mm (1.26in)	40mm (1.57in)	48mm (1.89in)	20mm (0.79in)

Item	Description	Part Number
PLF01-12	Fix bearing for 12mm slider	0150-3085
PLF01-20	Fix bearing for 20mm slider	0150-3083
PLF01-28	Fix bearing for 28mm slider	0150-3087
PLL02-12	Floating bearing for PL01-12 slider	0150-3111
PLL01-19	Floating bearing for PL01-19 slider	0150-3335
PLL01-20	Floating bearing for PL01-20 slider	0150-3084
PLL01-27	Floating bearing for PL01-27 slider	0150-3294
PLL01-28	Floating bearing for PL01-28 slider	0150-3094
PLM01-20-MK	Mounting kit for PL01-20 slider	0150-3079
PLM01-28-MK	Mounting kit for PL01-28 slider	0150-3095

Wipers

LinMot stators can be equipped with wipers as an option. Wipers increase the duration of the maintenance interval, and allow simple re-lubrication using the integrated lube nipple and a grease gun. The wipers also keep the slider free of grease or contaminants, and protect the stator from dirt.



Installation

LinMot stators can be equipped with wipers as an option.

Wipers increase the duration of the maintenance interval, and allow simple re-lubrication using the integrated lube nipple and a grease gun.

The wipers also keep the slider free of grease or contaminants, and protect the stator from dirt.

Wipers

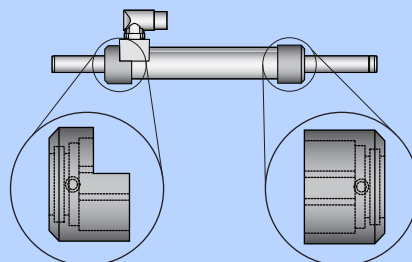

Rear Wiper

Front Wiper

Material

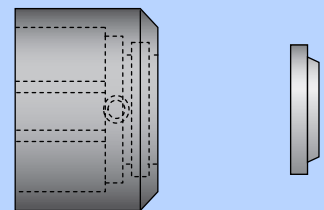

Housing: POM

Wipers: H-PU

Available Wipers

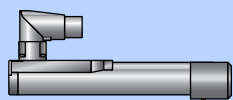

P01-23x80

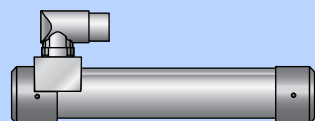

P01-37x120

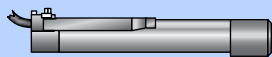

P01-23x160

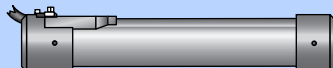

P01-37x240

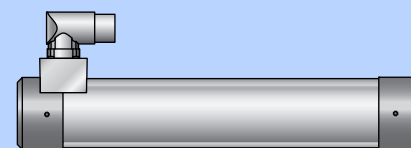

P01-48x240

Dimensions and ordering information

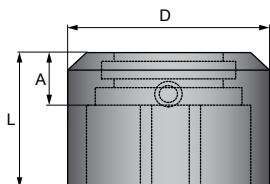

Item	D	L	A	Weight
PA01-23	29mm (1.14in)	33mm (1.30in)	14mm (0.55in)	0.014kg
PA01-37	45mm (1.77in)	32mm (1.26in)	12mm (0.47in)	0.028kg
PA01-37R	45mm (1.77in)	37mm (1.45in)	12mm (0.47in)	0.026kg
PA01-37R Kabel	45mm (1.77in)	40mm (1.57in)	12mm (0.47in)	0.030kg
PA01-48	58mm (2.28in)	32mm (1.26in)	14mm (0.55in)	0.056kg
PA01-48R	58mm (2.28in)	32mm (1.26in)	14mm (0.55in)	0.050kg

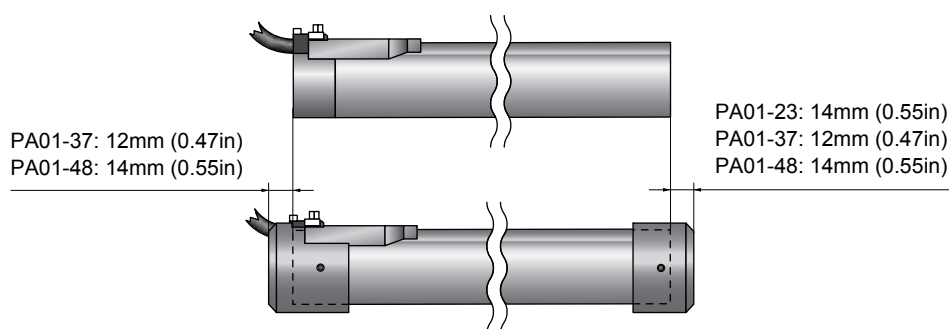

Item	Description	Part Number
PA01-23/12-F	Wiper for PS01-23x... (front wiper)	0150-3125
PA01-37/19-F	Wiper for PS01-37x... (front wiper for high clearance sliders)	0150-3225
PA01-37/19-R	Wiper for PS01-37x...(-C rear wiper for high clearance sliders)	0150-3226
PA01-37/19-R cable	Wiper for PS01-37x... (cable rear wiper for high clearance sliders)	0150-3227
PA01-37/20-F	Wiper for PS01-37x... (front wiper)	0150-3126
PA01-37/20-R	Wiper for PS01-37x...(-C rear wiper)	0150-3201
PA01-37/20-R cable	Wiper for PS01-37x...(-cable rear wiper)	0150-3221
PA01-48/27-F	Wiper for PS01-48x... (front wiper for high clearance sliders)	0150-3228
PA01-48/27-R	Wiper for PS01-48x...(-C rear wiper for high clearance sliders)	0150-3229
PA01-48/28-F	Wiper for PS01-48x... (front wiper)	0150-3127
PA01-48/28-R	Wiper for PS01-48x...(-C rear wiper)	0150-3202

External Position Sensor

Non-contacting measuring position sensors, using magnets with integrated processing electronics and differential encoder outputs for the E1100 series Servo Drives.

Together with the MB01-1000 magnetic band, the MS01/D position sensor is part of a high-resolution, robust, linear measurement system.

Features:

- Simple installation, by sticking on the magnetic band
- IP67 protection class, not sensitive to dust, moisture, or dirt
- Status display with LEDs directly at the sensor head
- Highest precision - Resolution 0.001mm - System accuracy $\pm 0.01\text{mm}$.
- Allows high travel speeds of up to 3 m/s
- Compatible with the E1100 series of LinMot Servo Drives.

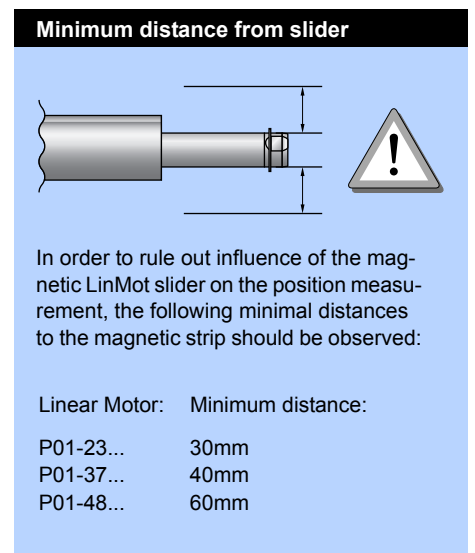
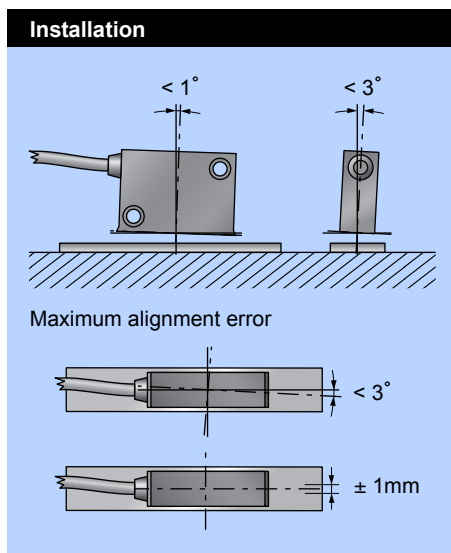
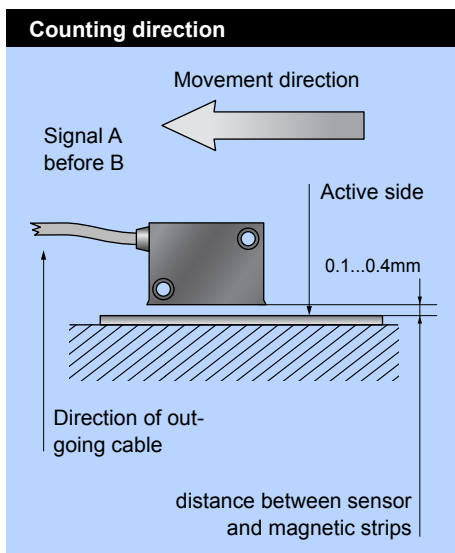
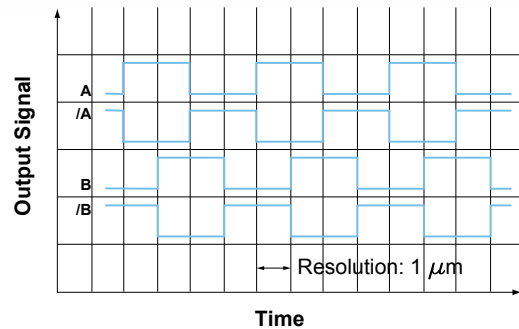

Dimensions

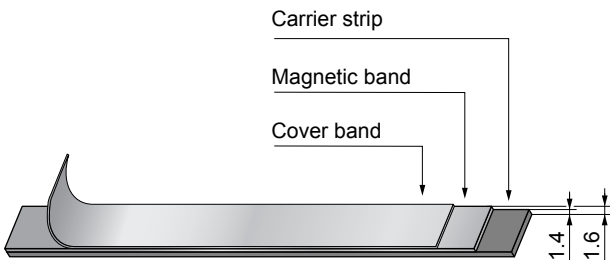
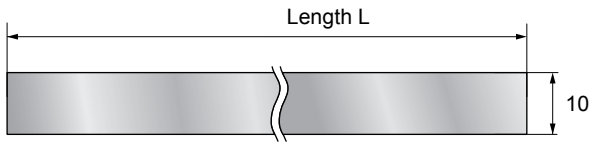
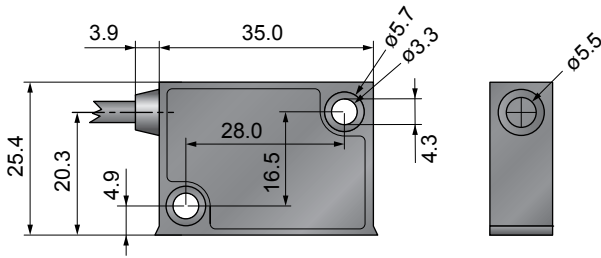

Cables

Cable length	2m, High Flex, PUR
Connector type	Dsub-9 (male)

Connector wiring

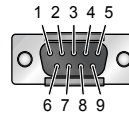

Pin 1	+5VDC
Pin 2	Channel /A
Pin 3	Channel /B
Pin 5	GND
Pin 6	Channel A
Pin 7	Channel B
Pin 4, 8, 9	n.c.

Technical data magnetic band

Order length	maximal stroke +3.0cm
Width	10mm
Carrier material	spring steel band
Precision class	$\pm 10 \mu\text{m/m}$
Temperature coefficient	$(11 \pm 1) \times 10^{-6} / ^\circ\text{K}$
Storage temperature range	-20...70°C
Storage temperature range	-40...70°C
Protection class	IP 67
Mounting	self adhesive magnetic band

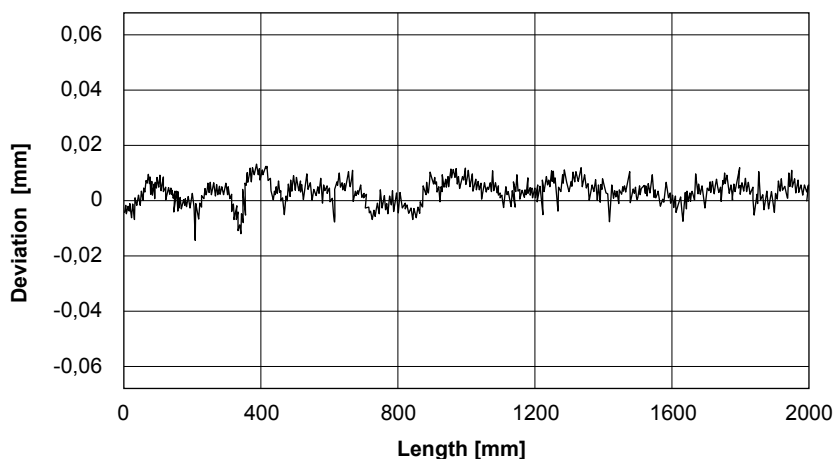

Ordering information

Item	Description	Part Number
MS01-1/D	Magnet sensor 1 μm , A/B (for 1mm magnetic band)	0150-1840
MB01-1000	Magnetic band, 1mm pole partitioning (per cm)	0150-1963
KS025-D/D-Encoder	Encoder Cable, High Flex (Length in m)	0150-3166
KS025-D/D15-Encoder	Encoder Cable, High Flex (Length in m)	0150-3168

Switched-Mode Power Supplies



Switched-Mode Power Supplies								
		24V		48V			72V	
Output power		150W	300 W	150 W	300 W	600 W	300W	600W
Input Specification								
Input voltage range	[VAC]	93...123 / 187...264						
Input frequency	[Hz]	47...63						
Input current at full load (230V)	[A]	1.6	2.9	1.6	2.9	5.0	2.9	5.0
Input current at full load (115V)	[A]	2.7	4.9	2.7	4.9	7.0	4.9	7.0
Maximum Inrush current (230V)	[A]	70	70	70	70	80	70	80
Internal fuse	[AT]	4	6.3	4	6.3	12	6.3	12
Output Specification								
Output voltage range	[VDC]	24...28		48...52			72...76	
Output current	[ADC]	6	12	3	6	12	4	8
Hold up time at full load	[ms]	30						
Over voltage protection	[% Uout]	140						
General Specification								
Operating temperature range		-25°C...70°C						
Power reduction above 50°C		2% / °C						
Storage temperature		-25°C...85°C						
Humidity		95% rel. H max.						
Switching frequency		67kHz typ.						
Efficiency		>85%						
Output voltage indicator		LED						
Isolation input - output		3'000 VAC (1 minute)						
Isolation input - case		2'000 VAC (1 minute)						
Isolation output - case		500 VAC (1 minute)						
Safety class (IEC 536)		Class 1						
Safety standards meets		IEC950 EN60950 CEs for SELV						
Conducted EMI according to		EN55022 Class B EN55011 Class B FCC-B						
Electromagnetic susceptibility EMC		EN61000-4-2 4kV / 8kV EN61000-4-3 10V / m EN61000-4-4 2kV EN61000-4-6 10V EN61000-4-8 30A / m						
Case / Protection class		Steel / IP20						
Mounting		DIN rail TS35, EN50022						

150 W

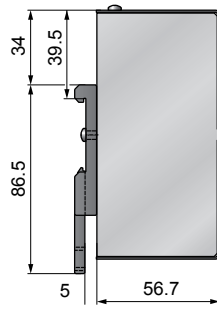
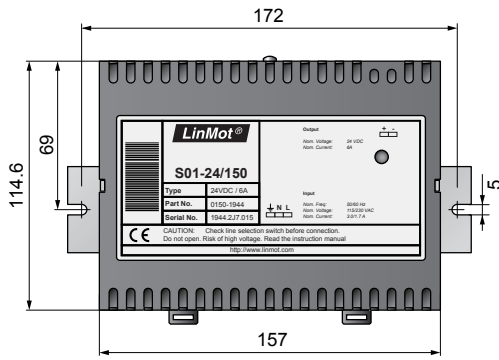

Option: Art. No. 0150-3039

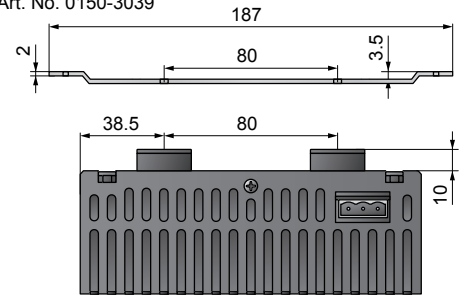

Weight: 800g

Item	Description	Part Number
S01-24/150	Switched-Mode Power Supply 24V/150W	0150-1944
S01-48/150	Switched-Mode Power Supply 48V/150W for E100/E200	0150-1940

300 W

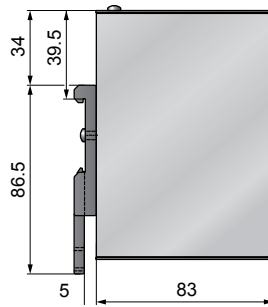
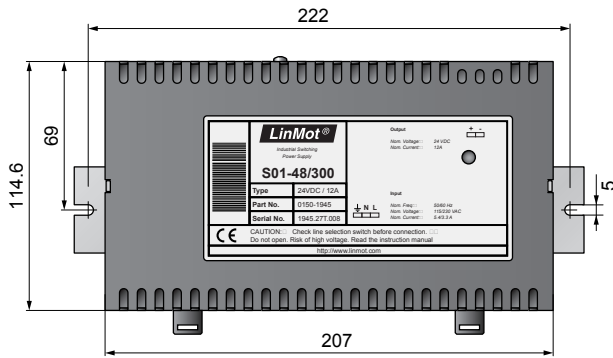

Option: Art. No. 0150-3040

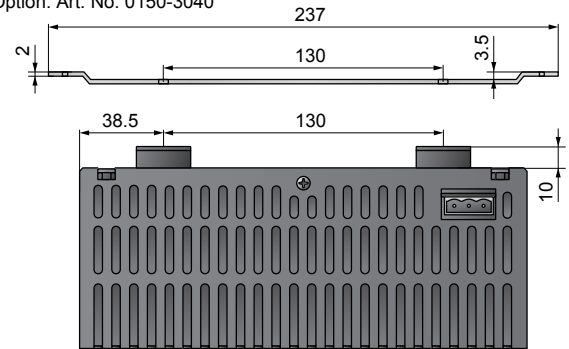

Weight: 1400g

Item	Description	Part Number
S01-24/300	Switched-Mode Power Supply 24V/300W	0150-1945
S01-48/300	Switched-Mode Power Supply 48V/300W for E400	0150-1941
S01-72/300	Switched-Mode Power Supply 72V/300W for E1001/E2001E4001	0150-1942

600 W

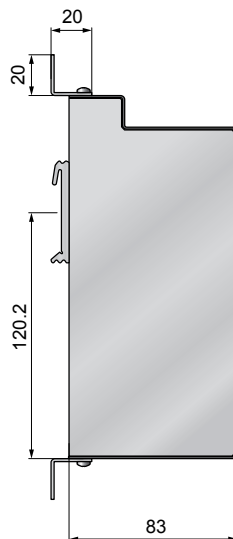
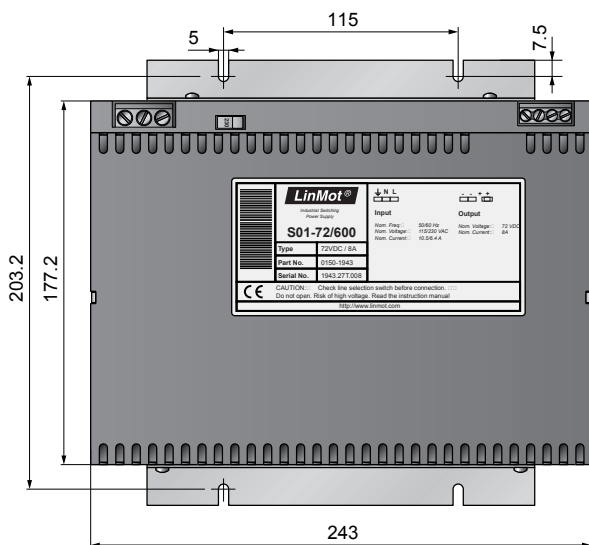

Option: Art. No. 0150-3041

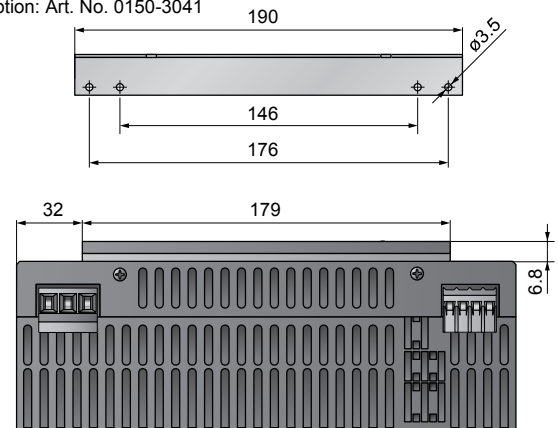

Weight: 2000g

Dimensions in mm

Item	Description	Part Number
S01-48/600	Switched-Mode Power Supply 48V/600W	0150-1946
S01-72/600	Switched-Mode Power Supply 72V/600W for E4001	0150-1943

Switched-Mode Power Supplies 72V



Power Supplies	S01-72/500	S01-72/1000
Input		
Input voltage range	93...123VAC / 187...264VAC automatical switchover	AC 3 x 340...550V
Power frequency	50...60Hz	50...60Hz
Efficiency	typ. 88%	typ. 91.5%
Input current limitation	=< 70A _{peak} typ. cold, =< 150A _{peak} hot	< 35A _{peak} typ. in cold state, < 70A _{peak} in hot state
Internal fuse	16ATH/250VAC	3x6.3A
External fuse		intern 3 x 6.3AT, external fuse with 16A to max. 32A necessary (C,D,K)
Output		
Preset range Vo	54 - 80VDC, factory setting: 72VDC ± 0.5%	56 - 80VDC, factory setting: 72VDC ± 0,15/0,2V
Max. Outputpower	480W	1000W
Powerboost	max. 150% (see chart)	max. 190-210% (see chart)
Start-up delay	< 1,5s (bei 230VAC)	250 ms typ.
Rise time	40 / 50 / 80ms typ.	20ms typ., 155ms typ. at 50.000 iF load
Back feeding voltage	up to 100VDC	up to 100VDC
Parallel connection	yes (max. 3 identical power supplies)	yes (max. 3 identical power supplies)
Regulation		
Line regulation	< 0.2% for Vo at Vi _{min} - Vi _{max}	< 0.3% for Vi _{min} - Vi _{max}
Load regulation	< 0.5% for Vo at Io 0 - 100% Boost-M. < 3.0% for Vo at Io 0 - 100% Parallel-M.	< 0.5% for Vo at Io 0 - 100% single operation < 3% for Vo at Io 0 - 100% parallel operation
Response time	typ. 1ms at Io 20 - 80%	1 ms typ. at Io 20 - 80%
Protection and Controlling		
Overtemperature protection	Switches off if inside temperature becomes to high, reconnection with hysteresis	Switches off if inside temperature becomes to high, reconnection with hysteresis
Safety/Standards		
	IEC 60950 / EN 60950 / VDE 0805 IP20, safety class 1, pollution degree 2 UL508/UL60950	EN 60950 / VDE 0805 / VDE 113 safety class I / VDE 0100 / IP20 CSA-C22.2 No 107 / CSA-C22.2 No. 60950-1-03 UL Std. 60950-1 / UL Std. 508 (Operation in Delta mains only for UL508) pollution degree 2
EMC		
Mains feedback / PFC	EN 61000-3-2 Class A only with ext. PFC 12mH/4,5A/230VAC	
Interference immunity	EN 61000-6-2 / EN 61000-4-2 / EN 61000-4-3	EN 61000-6-2 / EN61204-3
Flicker	EN 61000-3-3	EN 61000-3-3
ESD	EN 61000-4-2 8/15kV	EN 61000-4-2 8/15 kV
Electrical fields	EN 61000-4-3 noise level 10V/m (Krit. A)	EN 61000-4-3 noise level 10V/m
Burst	EN 61000-4-4 4kV (Krit.A)	input: EN 61000-4-4 4 kV Ausgang: EN 61000-4-4 2 kV
Surge	EN 61000-4-5 4/2kV (Krit.A)	input: EN 61000-4-5 2/4 kV output: EN 61000-4-5 0,5 kV
HF Immunity	EN 61000-4-6 noise level 10V (Krit.A)	EN 61000-4-6 noise level 10V
Voltage drop	EN 61000-4-11	EN 61000-4-11
Interference emission	EN 61000-6-4 EN 55011 Klasse B, Radiation depends on assembly	EN 61000-6-3 / EN61204-3 EN 55022 / EN 55011 class B, Radiation depends on assembly
Operating Data		
Temperature range	-25°C...70°C integral, temperature controlled fan, air intake bottom-up	-25...+70°C integral, temperature controlled fan, air intake bottom-up
Derating	3% / K at +60°C (see chart)	2% / K at +60°C
Weight	1.0kg	2.0 kg
	Operation in any assembly position possible. The distance between the surrounding components and the air admission and air exit holes should be at least 20 mm.	Operation in any assembly position possible. The distance between the surrounding components and the air admission and air exit holes should be at least 50 mm
Mechanics		
Assembly	All systems can be snapped onto a symmetrical 35mm DIN-rail	The power supply can be directly screwed onto the wall.

Current limiting characteristics (typ.)

S01-72/500

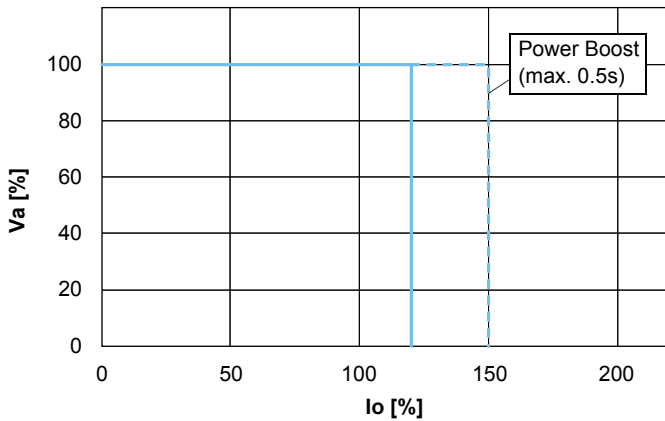

Boost 500ms up to 150% I_{nom} possible, after that min. 500ms break necessary

Current limiting characteristics (typ.)

S01-72/1000

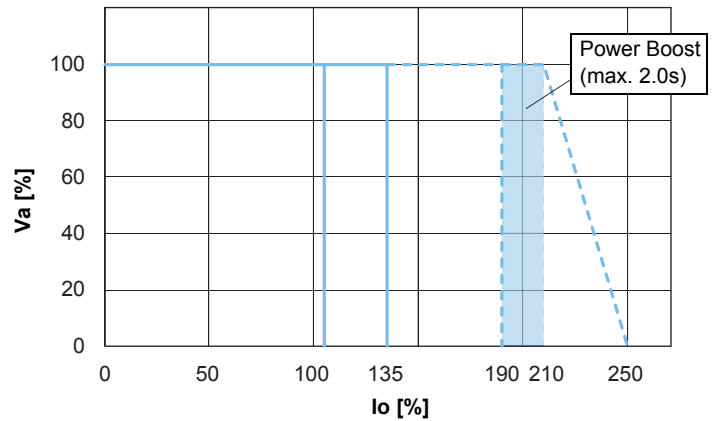

no boostbreak necessary, but the boosttime in the last 4s mustn't be longer a 2s, otherwise a boostbreak 1min is necessary (boostbreak <25ms will be not recognized)

Dimensions

S01-72/500

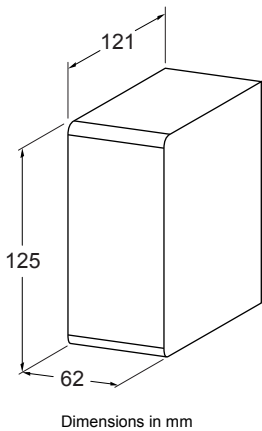

Dimensions in mm

Operation in any assembly position possible. The distance between the surrounding components and the air admission and air exit holes should be at least 20 mm. Please ensure that exhaust air is not immediately sucked in again.

Dimensions

S01-72/1000

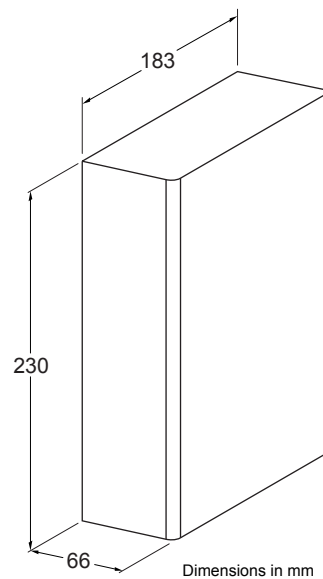

Dimensions in mm

Operation in any assembly position possible. The distance between the surrounding components and the air admission and air exit holes should be at least 50 mm. Please ensure that exhaust air is not immediately sucked in again.

Bestellinformationen

Artikel	Beschreibung	Artikelnummer
S01-72/500	Switched-Mode Power Supply 72V/500W	0150-1874
S01-72/1000	Switched-Mode Power Supply 72V/1000W	0150-1872

Transformer Supplies

Type T01 in modern industrial design, meets national, and international upcoming regulations. It was designed bearing following aspects in mind:

- ✓ 3 power classes:
420VA
900VA
1500VA
- ✓ 3 input voltage versions:
3x230VAC
3x400VAC
3x480VAC
- ✓ optimal layout to reduce surface area
- ✓ simple mounting via open-ended slot
- ✓ compact construction and low weight



T01-...-Multi

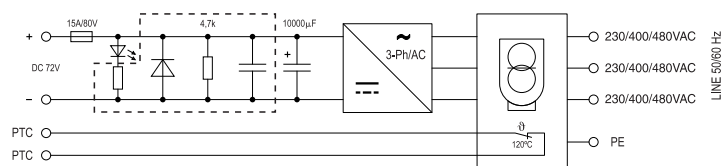

Use T01 only as Motor supplies for LinMot Servo Drives series E1100/B1100 and E1001. Do not use T01 supplies with series E100 or series E1000 Servo Drives!

Technical Data

3-Phase Transformer Supply with integrated rectifier bridge, LGD, PTC, DC-Link buffer capacitor and Output Fuse, output ripple 2%.

Test Voltage between Primary and Secondary Winding 4467V, 50Hz.

Maximum Power Dissipation:
45W(420VA)
75W(900VA)
110W(1500VA)

Suitable for Installation up to protection rating IP 20, insulation class E, max. ambient temperature 40°C.

Input and Output Voltage

Input:

T01-...-Multi 3x230/400/480 VAC, 50/60Hz

External Fuse: 2AT(420VA), 4AT(900VA), 8AT(1500VA)

Output:

T01-72/420 72 VDC, 5.8A (100%ED), 10A (35%ED), 15A (15%ED)

T01-72/900 72 VDC, 12A (100%ED), 20A (35%ED), 30A (15%ED)

T01-72/1500 72 VDC, 20A (100%ED), 33A (35%ED), 50A (15%ED)

Single Phase Transformer Supply

The T01-72/420-1ph is a single phase version with 208/220/230/240VAC 50/60Hz input voltage and 420VA output power.

The mechanical dimensions of the T01-72/420-1ph are the same as the three phase transformer supply with 900VA output power.

420 VA

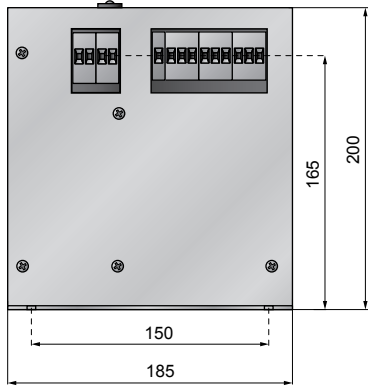

Weight: 6.6kg

Dimensions in mm

Item	Description	Part Number
T01-72/420-Multi	Transformer Supply 3x230/400/480 VAC, 50/60Hz, 420VA	0150-1869
T01-72/420-1ph	Transformer Supply 1x208/220/230/240VAC, 50/60Hz, 420VA*	0150-1859

*Dimensions see 900VA-Supply

900 VA

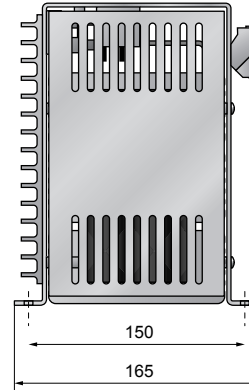
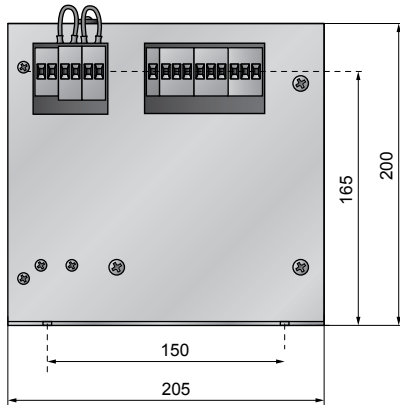

Weight: 10.6kg

Dimensions in mm

Item	Description	Part Number
T01-72/900-Multi	Transformer Supply 3x230/400/480 VAC, 50/60Hz, 900VA	0150-1870

1500 VA

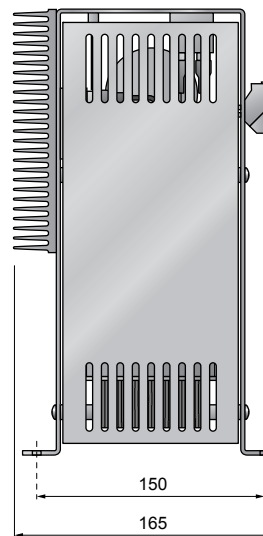
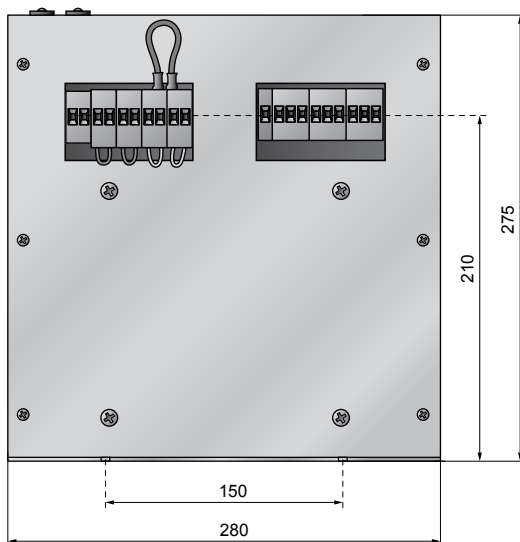

Weight: 17kg

Dimensions in mm

Item	Description	Part Number
T01-72/1500-Multi	Transformer Supply 3x230/400/480 VAC, 50/60Hz, 1500VA	0150-1871

Regeneration Resistor

The brake resistor is high-amperage and has a very high electric strength. It also features high pulse inhibition. Its compact form factor and the design of the connection elements make it easier to attach and install the resistor elements. Complete encapsulation provides protection from dirt and accidental contact with the high-voltage components.

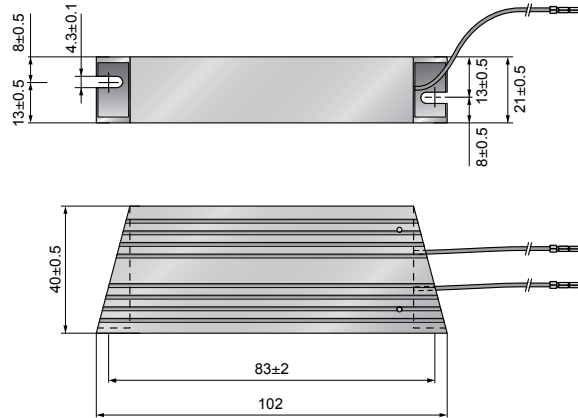

Connector Cable and Converter

Pre-assembled RS232 cable and USB converters for the connection between drive and PC for drive configuration with LinMot Talk.

RJ45 patch cable for fast CAN, RS485 and master encoder wiring on E1100 Servo Drive connectors X7/8 and X10/11.



Item	Description	Part Number
RR01-10/60	Regeneration Resistor 60W for E1100	0150-3088

Item	Description	Part Number
RS232 PC config. cabel 2m	for E100/E1001	0150-3009
RS232 PC config. cabel 2m	for E100/E1001/E1100/B1100	0150-3307
RS232 PC config. cabel 2.5m	for E1200/E1400	0150-2143
USB-Serial Converter	USB to 9-pin Serial Converter	0150-3110
USB-CAN Converter	USB to CAN Converter for E1100	0150-3134
RJ45-08/0.3	RJ45 patch cable 0.3m for E1100	0150-1852
RJ45-08/0.6	RJ45 crossover patch cable 0.6m	0150-1853
RJ45/RJ45-0,2-ML1	MC-Link cable 0,2m	0150-3308

Configuration Interface

Servo Drive series E100/E1001 use the RS232 interface for configuration. If the RS232 interface is used for communication with the overlaid control, configuration and debugging may be done over the RS485 Interface.

Servo Drive series E1100 may be configured over RS232 or CAN Interface. Configuration over CAN bus permits multi axes configuration. The CAN bus is also used for configuration and debugging if the serial interface RS232/RS485 is occupied by the communication to the overlaid control.

USB-RS232 Converter

As many new PC's and Laptops do not have an RS232 interface any more and many available USB-RS232 converters are giving comatibility problems, LinMot has it's own converter. The necessary drivers are installed automatically together with the LinMot Talk software.

The USB-RS232 converter may be used for drive configuration on the series E100/E1001 and series E1100 drives with a PC's without RS232 interface.

USB-CAN Converter

The USB-CAN converter is used with the series E1100 drives for multi axes configuration or configuration, debugging an optimization if the serial interface RS232 or RS485 is used for communication with the overlaid control.

Control Box B01-4
for E100/1000
Drive



Control Box
B01-E1100 for
E1100 Drive



Control Box

The B01-4 Control Box allows the user to start up the LinMot system quickly. The box is used with the AT and MT Servo Drives. It allows manual setting of control signals for the Servo Drive, using a potentiometer and buttons, and is primarily intended for testing.

The B01-1100 Control Box allows the user to start up the LinMot an E1100 system quickly. It allows manual setting of control signals for the Servo Drive and is primarily intended for startup and testing.

Item	Description	Part Number
B01-4 230V / 50HZ	Control Box for E100/E1001 Drive (230VAC)	0150-1930
B01-4 115V / 60HZ	Control Box for E100/E1001 Drive (115VAC)	0150-1931
B01-E1100	Control Box for E1100 Drive	0150-1970
B01-B1100	Control Box for B1100 Drive	0150-2110

Control Box

The Control Boxes provide the following functionalities:

- Starting and stopping program sequences
- Initialization
- Analog position targets using potentiometer
- Setting trigger signals
- External setting of trigger signals and position values
- Status message display

B01-4

The scope of delivery includes:

- 1 Control Box, LinMot® B01-4
- 1 Plug-in power supply 230V / 50Hz and 115V / 60Hz
- 2 Connector cables: 'Control Box'-Servo Drive

B01-E1100/B1100

The scope of delivery includes:

- 1 Control Box, LinMot® B01-E1100 or B01-B1100
- 2 Connector cables: 'Control Box'-Servo Drive