

intelligence

AUTOMATES PROGRAMMABLES

m o t i o n
la force de la gamme !



transtechnik
servomécanismes

Delta DVP series PLC is built-in with RS-232 and RS-485 communication port and supports Ethernet, DeviceNet, CANopen networks, working flexibly with the peripheral equipment and devices.

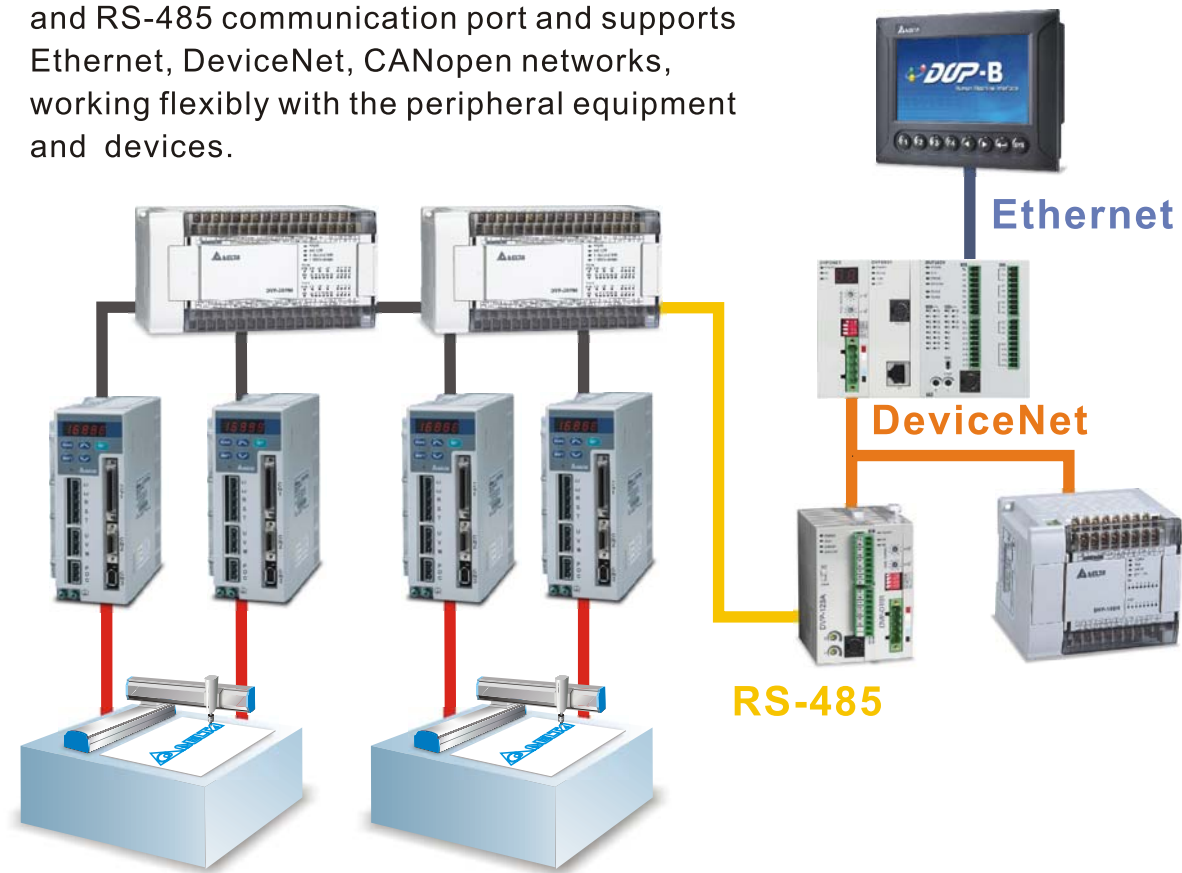

DVP-EH2

Functional Standard Type MPU



- EH2 series includes 3 types of MPU:
- With 7 types of I/O
 - 40EH2 series with 4-axis control
 - L type with left-side extension function

DVP-SV

Functional Space-Saving MPU



SV series satisfies all kinds of applications. It supports simple I/O control and high-grade 4-axis motion control, as well as all kinds of industrial network modules. Left side is extendable by special extension modules and right side by general extension module, totaling 16 extension modules extendable to DVP-SV.

DVP-PM

Motion Control MPU



DVP-PM is able to conduct 2-axis synchronous control and is designed for professional motion control. It is compatible with G-Code/M-Code and is the multi-axis extendable control system for the new generation.

Delta DVP series programmable logic controllers offer high-speed, stable and highly reliable applications in all kinds of industrial automation machines. In addition to fast logic operation, bountiful instructions, multiple function extension cards, the cost-effective DVP series also supports various communication protocols, connecting the industrial automation system as a whole into a complete Delta solution for the users.

Contents

	Page
DVP-E Series MPU	3
DVP-S Series MPU	5
DVP-PM Series MPU	7
DVP-SV Series MPU	9
Extension	11
Electrical Specifications & Dimension	15
Network Structure	17
Ordering Information	19

Execution Efficiency

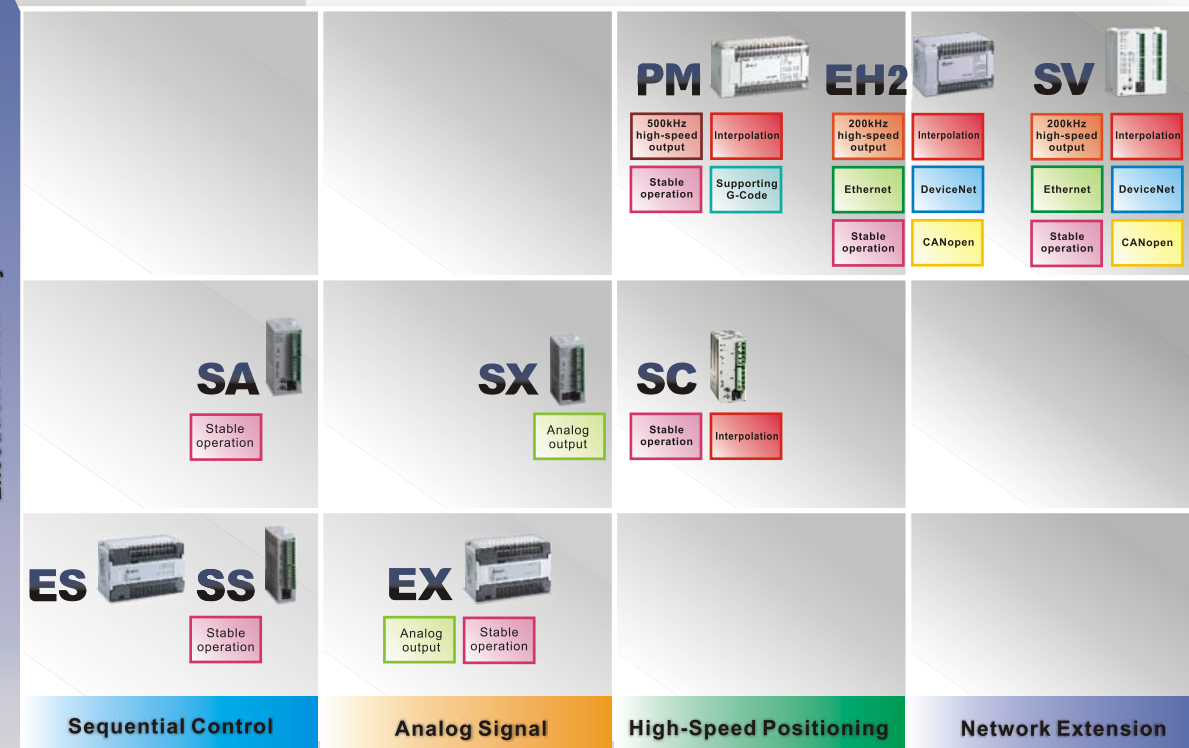

DVP-E Series MPU



DVP-EX

- Built-in 4-channel analog input and 2-channel analog output
- Integral communication functions
- Lowest-cost MPU with analog functions

Specification & Performance

MPU points: 20(8DI/6DO, 4AI/2AO)
 Max. I/O points: 238
 Program capacity: 4k steps
 Communication port: Built-in RS-232 and RS-485, compatible with Modbus ASCII/RTU communication protocol

High-Speed Pulse Output

Supports 2-point (Y0, Y1) independent high-speed pulse output, with frequency of up to 10kHz.

Built-in High-Speed Counters

1 phase 1		1 phase 2		2 phase 2	
Points	Bandwidth	Points	Bandwidth	Points	Bandwidth
2/2	20kHz/10kHz	1	20kHz	1	4kHz

*Bandwidth refers to the max. counting bandwidth of a single counter.

Built-in Analog Input/Output

Analog Input		Analog Output	
Points	Resolution	Points	Resolution
4	10 bit	2	8 bit
Specification	-20~20mA or -10~10V	Specification	0~20mA or 0~10V

DVP-ES

- High reliability
- Maximum 256 I/O points extendable
- Most economical solution to small PLC sequential control and communication monitoring

Specification & Performance

MPU points: 14/24/30/32/40/60
 Max. I/O points: 256
 Program capacity: 4k steps
 Communication port: Built-in RS-232 and RS-485, compatible with Modbus ASCII/RTU communication protocol

High-Speed Pulse Output

Supports 2-point (Y0, Y1) independent high-speed pulse output, with frequency of up to 10kHz.

Built-in High-Speed Counters

1 phase 1		1 phase 2		2 phase 2	
Points	Bandwidth	Points	Bandwidth	Points	Bandwidth
2/2	20kHz/10kHz	1	20kHz	1	4kHz

*Bandwidth refers to the max. counting range of a single counter.

DVP-EH2

- Outstanding operation performance
- Built-in large space for program and data storage
- Supports more than 203 application instructions
- 2-axis linear/arc interpolation motion control
- Run with various high-speed function extension modules/function cards for all kinds of real-time applications

Specification & Performance

MPU points: 16/20/32/40/48/64/80
 Max. I/O points: 512
 Program capacity: 16k steps
 Instruction execution speed: 0.24μs (for basic instruction)
 Communication port: Built-in RS-232 and RS-485, compatible with Modbus ASCII/RTU communication protocol.
 Data register: 10,000 words
 File register: 10,000 words

High-Speed Pulse Output

The pulse outputs 20-point and 32-point models support 2-point 200kHz pulse outputs (Y0, Y2).
 The 40-point models support 2-group A, B phase 200kHz pulse outputs (Y0, Y1), (Y2, Y3) and 2-point 200kHz pulse output (Y4, Y6)

Built-in 4 Hardware High-Speed Counters

Standard		Hardware High-Speed Counter					
		1 phase 1		1 phase 2		2 phase 2	
Points	Bandwidth	Points	Bandwidth	Points	Bandwidth	Points	Bandwidth
6	10kHz	2/2	200kHz/20kHz	2/2	200kHz/20kHz	1	200kHz/20kHz

*Bandwidth refers to the max. counting range of a single counter.

Outstanding Operation Performance

CPU + ASIC dual processors support floating point operations. The maximum execution speed of basic instructions can reach up to 0.24μs

Flexible Function Extension Modules / Function Cards

Multiple function extension modules/function cards contain additional functions of analog I/O, temperature measurement, single-axis motion control, high-speed counting and a 3rd series communication port, etc.

PLC EASY LINK

PLC EASY LINK allows users to link maximum 32 units to the network without having to install extra communication extension modules.

Linear/Arc Interpolation Motion Control

Supports the new linear/arc interpolation motion control instructions. Together with high-speed pulse outputs, DVP-EH2 is able to perform 2-axis synchronous control.

High-Speed Special Extension Module

Used together with the new special extension modules, DVP-EH2 is able to greatly shorten the data transmission time between MPU and its extension modules as well as enhancing the execution efficiency of the program.

DVP-S Series MPU



DVP-SS

- Suitable for basic applications
- Compact size
- Can run with special extension modules

Specification & Performance

MPU points: 14
 Max. I/O points: 238
 Program capacity: 4k steps
 Communication port: Built-in RS-232 and RS-485, compatible with Modbus ASCII/RTU communication protocol

High-Speed Pulse Output

Supports 2-point (Y0, Y1) independent high-speed pulse output, with frequency of up to 10kHz.

Supports PID Auto-tuning

After the operation is completed, the parameters will be saved automatically.

Built-in 4-Group High-Speed Counter

1 phase 1		1 phase 2		2 phase 2	
Points	Bandwidth	Points	Bandwidth	Points	Bandwidth
2/2	20kHz/10kHz	1	20kHz	1	4kHz

*Bandwidth refers to the max. counting range of a single counter.

DVP-SA

- Large program capacity to enhance operation performance
- Best extensibility

Specification & Performance

MPU points: 12
 Max. I/O points: 236
 Program capacity: 8k steps
 Communication port: Built-in RS-232 and RS-485, compatible with Modbus ASCII/RTU communication protocol

High-Speed Pulse Output

Supports 2-point (Y0, Y1) independent high-speed pulse output, with frequency of up to 50kHz (Y0) and 10kHz (Y1).

Maximum 8 Special Modules Extendable

For analog I/O, temperature measurement, input point DIP switch, PROFIBUS/DeviceNet communication module, single-axis motion control.

Built-in High-Speed Counters

1 phase 1		1 phase 2		2 phase 2	
Points	Bandwidth	Points	Bandwidth	Points	Bandwidth
2/4	20kHz/10kHz	1	20kHz	1	4kHz/25kHz

*Bandwidth refers to the max. counting range of a single counter.

DVP-SX

- Built-in 2-channel analog input and 2-channel analog output
- Can run with 8 special extension modules

Specification & Performance

MPU points: 10(4DI/2DO, 2AI/2AO)
 Max. I/O points: 230
 Program capacity: 8k steps
 Communication port: Built-in RS-232 and RS-485, compatible with Modbus ASCII/RTU communication protocol

High-Speed Pulse Output

Supports 2-point (Y0, Y1) independent high-speed pulse output, with frequency of up to 50kHz (Y0) and 10kHz (Y1).

Built-in High-Speed Counters

1 phase 1		1 phase 2		2 phase 2	
Points	Bandwidth	Points	Bandwidth	Points	Bandwidth
2/4	20kHz/10kHz	1	20kHz	1/1	4kHz/25kHz

*Bandwidth refers to the max. counting bandwidth of a single counter.

Built-in Analog I/O

Analog Input				Analog Output			
Points				Points			
2				2			
Resolution	12 bit(V)/11 bit(I)			Resolution	12 bit		
Specification	-20 ~ 20mA or -10 ~ 10V			Specification	-20 ~ 20mA or -10 ~ 10V		

DVP-SC

- 100kHz high-speed pulse output and 100kHz pulse counting

Specification & Performance

MPU points: 12
 Max. I/O points: 236
 Program capacity: 8k steps
 Communication port: Built-in RS-232 and RS-485, compatible with Modbus ASCII/RTU communication protocol

High-Speed Pulse Output

Supports 2-point (Y10, Y11) independent high-speed pulse output, with frequency of up to 100kHz (Total bandwidth:130kHz).

Supports Handy Position Control Instructions

By ZRN (zero return), DRVA (absolute position), and DRVI (relative position), DVP-SC is able to complete all kinds of motion controls by working with Delta servos.

Built-in 6-Group High-Speed Counter

1 phase 1		1 phase 2		2 phase 2	
Points	Bandwidth	Points	Bandwidth	Points	Bandwidth
2/4/2	20kHz/10kHz/100kHz	1/1	20kHz/100kHz	1/1	4kHz/50kHz

*Bandwidth refers to the max. counting bandwidth of a single counter.

DVP-PM Series MPU

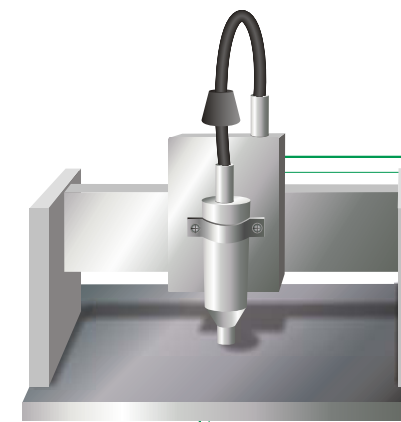

Application

DVP-PM can be applied in SMT machine, cutting machine, packaging machine, shoe-making machine, welding machine, and machines requiring fast and accurate 2D positioning.

As MPU or Extension Module



DVP-PM can be used as a PLC MPU as well as an extension module. It is compatible with all EH2 series extension modules.

Compatible with G-Code



Drawing a circle

Converting to G-Code



Downloading to DVP-PM

The graphic is converted into G-Code and further downloaded to DVP-PM before being drawn.

Professional Motion Controller

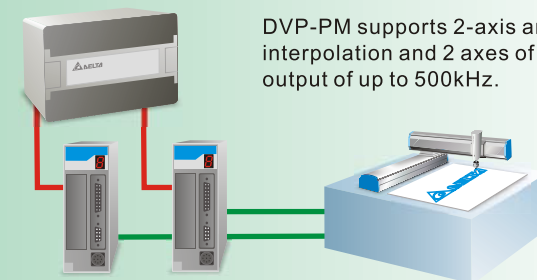

DVP-PM supports 2-axis arc/linear interpolation and 2 axes of pulse output of up to 500kHz.

PMSoft

Software for DVP-PM

- Importing G-Code
- Tracing trajectory
- Off-line simulation

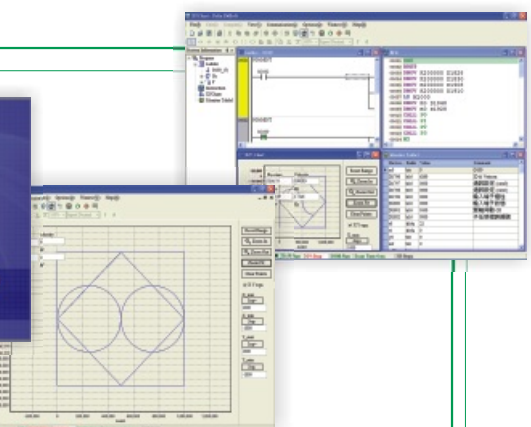

DVP-PM

- 2-axis linear/arc interpolation motion control
- Maximum pulse output frequency: 500kHz
- Compatible with G-Code/M-Code

Specification & Performance

MPU points: 16
 Max. I/O points: 512
 Program capacity: 64k steps
 Communication port: Built-in RS-232 and RS-485, compatible with Modbus ASCII/RTU communication protocol
 Data register: 10,000 words
 *Latched

500kHz High-Speed Pulse Output

Built-in 2-group A, B phase differential signal output
 X-axis pulse output: (FP0+, FP0-), (RP0+, RP0-)
 Y-axis pulse output: (FP1+, Fp1-), (RP1+, RP1-)

Supports MPG & Multiple External Signal Inputs

The direct input of external signals are able to complete real-time feedback and motion control.

Linear/Arc Interpolation Motion Control; Compatible with G-Code

The handy CAM software compiles CAD file into G-Code and uploads it into DVP-PM for executing complicated 2-axis linear/arc interpolation motion control in for example CNC machines.

Model	Spec
DVP20PM00D	

AC power supply Input(points) Output(points) Relay output

Motion Control MPU, as well as Extension Module

Apart from serving as an MPU for motion control operating independently, DVP-PM can further be the extension module with motion control for EH2 series MPU. The user has to pre-plan the motion schedule and upload it to DVP-PM (as slave) and EH2 series MPU only needs to give "start" and "stop" instructions. As an extension module, DVP-PM works independently and Does not affect the scan time of EH2 series MPU.

Compatible with the Function Extension Modules of EH2 Series MPU

DVP-PM offers flexible applications while being compatible with the points/function extension modules of EH2 series MPU.

DVP-SV Series MPU



DVP-SV

- Outstanding operation performance
- High program planning capacity
- Left-side high-speed function extension interface
- Linear/arc interpolation motion control

Specification & Performance

MPU points: 28
 Max. I/O points: 512
 Program capacity: 16k steps
 Instruction execution speed: 0.24μs (for basic instruction)
 Communication port: Built-in RS-232 and RS-485, compatible with Modbus ASCII/RTU communication protocol
 Data register: 10,000 words
 File register: 10,000 words

High-Speed Pulse Output

Supports 2-group (Y0, Y1) (Y2, Y3) A,B phase pulse output, with frequency of up to 200kHz.
 Supports 2-point (Y4, Y6) high-speed pulse output, with frequency of up to 200kHz.

Outstanding Operation Performance

CPU + ASIC dual processors support floating point operations. The maximum execution speed of basic instructions can reach 0.24μs

Model	Spec
DVP28SV11R	—DC— 16 12 R→
DVP28SV11T	—DC— 16 12 T→

—DC— DC power supply C Input(points) ↑ Output(points)
 T→ Transistor output R→ Relay output

Left-Side High-Speed Function Extension Module

The parallel data transmission bus greatly enhances the efficiency of data exchange for real-time control. Special extension modules: analog I/O, temperature measurement, single-axis motion control, DeviceNet Master module, CANopen Master and Ethernet network module.

Linear/Arc Interpolation Motion Control

The new handy point-to-point linear motion instruction (PPMR/PPMA) and arc interpolation motion instruction (CIMR/CIMA) allow users to enter only 4 parameters to complete the control.

Built-in 4-Group Hardware High-Speed Counters

Standard		Hardware High-Speed Counter					
1 phase 1		1 phase 1		1 phase 2		2 phase 2	
Points	Bandwidth	Points	Bandwidth	Points	Bandwidth	Points	Bandwidth
6	10kHz	2/2	200kHz/20kHz	2/2	200kHz/20kHz	2/2	200kHz/5kHz

*Bandwidth refers to the max. counting range of a single counter.

High-Speed Parallel Extension Modules

Communication

- DeviceNet Master DVPDNET-SL
- Ethernet DVPEN01-SL
- CANopen Master DVPCOPM-SL

Analog Function Extension

- Analog Input* DVP04AD-SL
- Analog Output* DVP04DA-SL
- Mixed Analog I/O* DVP06XA-SL

Temperature Measurement

- Sensor: PT100* DVP04PT-SL
- Sensor: J, K Thermocouple* DVP04TC-SL

Motion Control

- Single-Axis* Position Control DVP01PU-SL

Serial Extension Modules

I/O Extension

- Input Point Extension DVP08SM11N, DVP16SM11N
- Output Point Extension DVP06SN11R, DVP08SN11R/T
- Mixed I/O Extension DVP08SP11R/T, DVP16SP11R/T, DVP16SP11TS(PNP)

Pin-headed Input

- DVP32SM11N

Pin-headed Output

- DVP32SN11TN

Digital Switch

- DVP08ST11N

Analog Function Extension

- Analog Input DVP04AD-S, DVP06AD-S
- Analog Output DVP04DA-S, DVP02DA-S
- Mixed Analog I/O DVP06XA-S

Temperature Measurement

- Sensor: PT100 DVP04PT-S
- Sensor: J, K, R, S, T Thermocouple DVP04TC-S

Motion Control

- Single-Axis Position Control DVP01PU-S

Communication

- PROFIBUS Slave DVPPF01-S
- DeviceNet Slave DVPDT01-S

Power Supply

- DVPPS01
- DVPPS02

*Notes:
 1. Contact our sales for the official release date of "high-speed parallel extension modules".
 2. High-speed parallel extension modules are compatible with DVP32EH00R2-L and DVP32EH00T2-L

For more detailed specifications, visit :<http://www.delta.com.tw/industrialautomation> for all user's manuals of DVP-PLC

Extension

DVP-EH2

Small PLC with the strongest operation performance!



- Maximum 512 points
- 200kHz high-speed pulse output
- New high-speed special extension modules
- Linear/arc interpolation motion control
- L type with left-side extension fauction

Function Cards

- Convert COM2 RS-485 into RS-232/422 interface

DVP-F232



DVP-F422



- Additional 3rd Communication Port

DVP-F232S



DVP-F485S



- Analog I/O

DVP-F2DA



DVP-F2AD



- Digital Input Point Extension

DVP-F4IP



- Transistor Output

DVP-F2OT



- Analog Input

DVP-F6VR



- Input Point DIP Switch

DVP-F8ID



- Frequency Measurement Card

DVP-F2FR



Connection with Other Devices

HMI



TP



Servo



VFD



Accessories

- Data Back-up Card

DVP-256FM

DVPPCC01



- Handheld Programming Panel

DVP-HPP



- Digital Display Panel

DVPDU01



- Data Transmission Cable

DVPACAB2A30



- Connector for DVP-EH/PM Series PLC

DVPAEXT01-H

■ MPU-Extension Unit Connection Cable

DVPACAB4A09(0.9m)

DVPACAB4A18(1.8m)



Model Name	Specification
DVP16EH00R2	—AC— 8 I 8 R
DVP16EH00T2	—AC— 8 I 8 T
DVP20EH00R2	—AC— 12 I 8 R
DVP20EH00T2	—AC— 12 I 8 T
DVP32EH00R2	—AC— 16 I 16 R
DVP32EH00T2	—AC— 16 I 16 T
DVP32EH00M2	—AC— 40 I 40 T
DVP32EH00R2-L*	—AC— 16 I 16 R
DVP32EH00T2-L*	—AC— 16 I 16 T
DVP40EH00R2	—AC— 24 I 16 R
DVP40EH00T2	—AC— 24 I 16 T
DVP48EH00R2	—AC— 24 I 24 R
DVP48EH00T2	—AC— 24 I 24 T
DVP64EH00R2	—AC— 32 I 32 R
DVP64EH00T2	—AC— 32 I 32 T
DVP80EH00R2	—AC— 40 I 40 R
DVP80EH00T2	—AC— 40 I 40 T

—AC— AC power supply I Input (points) O Output (points) R Relay output T Transistor output

* Supporting SV series left-side high-speed extension modules.

Serial Extension Modules

I/O Extension Modules

- Input Point Extension

DVP08HM11N

DVP16HM11N



- Output Point Extension

DVP08HN11R/T

DVP32HN00R/T



- Mixed I/O Extension

DVP08HP11R/T

DVP16HP11R/T

DVP32HP00R/T

DVP48HP00R/T



Analog Function Extension

- Analog Input

DVP04AD-H2

V : 14 bit

I : 13 bit



- Analog Output

DVP04DA-H2

V : 12 bit

I : 12 bit



- Mixed Analog I/O

DVP06XA-H2

Input 4CH/Output 2CH

V : 12 bit V : 12 bit

I : 11 bit I : 12 bit



Temperature Measurement

- Sensor: PT100

DVP04PT-H2



- Sensor: J, K, R, S, T Thermocouple

DVP04TC-H2



- The left-side high-speed parallel extension modules for DVP-SV are compatible with DVP32EH00R2-L and DVP32EH00T2-L

Motion Control

- Single-Axis Position Control

DVP01PU-H2



- 1-Channel High-Speed Counter

DVP01HC-H2



Extension



Most cost-effective solution to sequential control!

Compact Appearance; Flexible Extension!

DVP-ES

256 Points
Pulse Output 10kHz



DVP-EX

256 Points
Pulse Output 10kHz
Analog Input/Output



Model Name	Specification
DVP14ES00R2	—AC— 8 6 R→
DVP14ES00T2	—AC— 8 6 T→
DVP24ES00R2	—AC— 16 8 R→
DVP24ES00T2	—AC— 16 8 T→
DVP24ES11R2	—DC— 16 8 R→
DVP30ES00R2	—AC— 18 12 R→
DVP30ES00T2	—AC— 18 12 T→
DVP32ES00R2	—AC— 16 16 R→
DVP32ES00T2	—AC— 16 16 T→
DVP40ES00R2	—AC— 24 16 R→
DVP40ES00T2	—AC— 24 16 T→
DVP60ES00R2	—AC— 36 24 R→
DVP60ES00T2	—AC— 36 24 T→

—AC— AC power supply C Input (points) U Output (points)
—DC— DC power supply R→ Relay output T→ Transistor output

Model Name	Specification
DVP20EX00R2	—AC— 8DI, 4AI/6DO, 2AO R→
DVP20EX00T2	—AC— 8DI, 4AI/6DO, 2AO T→
DVP20EX11R2	—DC— 8DI, 4AI/6DO, 2AO R→

—AC— AC power supply C Input (points) U Output (points)
—DC— DC power supply R→ Relay output T→ Transistor output

DVP-SS

The best micro-MPU for basic applications



Model	Spec
DVP14SS11R2	—DC— 8 6 R→
DVP14SS11T2	—DC— 8 6 T→

R→ Relay output C Input (points) U Output (points)
—DC— DC power supply T→ Transistor output

DVP-SX

Built-in analog input/output



Model	Spec
DVP10SX11R	—DC— R→ 4DI, 2AI/2DO, 2AO
DVP10SX11T	—DC— T→ 4DI, 2AI/2DO, 2AO

—DC— DC power supply T→ Transistor output
R→ Relay output

DVP-SA

Advanced performance
8k steps program capacity



Model	Spec
DVP12SA11R	—DC— 8 4 R→
DVP12SA11T	—DC— 8 4 T→

R→ Relay output C Input (points) U Output (points)
—DC— DC power supply T→ Transistor output

DVP-SC

Max. 100kHz pulse output
Max. 100kHz pulse counting



Model	Spec
DVP12SC11T	—DC— 8 4 R→

R→ Relay output C Input (points) U Output (points)
—DC— DC power supply T→ Transistor output

I/O Extension Modules

■ Input Point Extension
DVP08XM11N
DVP16XM11N



■ Output Point Extension
DVP08XN11R/T
DVP16XN00R/T
DVP24XN11R/T
DVP24XN00R/T



■ Mixed I/O Extension
DVP08XP11R/T
DVP24XP11R/T
DVP24XP00R
DVP32XP00R/T



I/O Extension Modules

■ Input Point Extension
DVP08SM11N



■ Output Point Extension
DVP06SN11R
DVP08SN11R/T



■ Mixed I/O Extension
DVP08SP11R/T
DVP16SP11R/T



Connection with Other Devices



Accessories

■ Data Back-up Card
DVPPCC01



■ Handheld Programming Panel
DVP-HPP



■ Data Transmission Cable
DVPACAB2A30(3m)



Analog Function Extension Modules

■ Analog Input
DVP04AD-S
V : 14 bit
I : 13 bit



■ Analog Output
DVP04DA-S
DVP02DA-S
V : 12 bit
I : 12 bit



■ Mixed Analog I/O
DVP06XA-S
Input 4CH / Output 2CH
V : 12 bit V : 12 bit
I : 11 bit I : 12 bit



Temperature Measurement Modules

■ Sensor: PT100
DVP04PT-S



■ Sensor: J, K, R, S, T
Thermocouple
DVP04TC-S



Communication Modules

■ PROFIBUS Slave
DVPPF01-S



■ DeviceNet Slave
DVPDT01-S



Motion Control Modules

■ Single-Axis Position Control
DVP01PU-S



■ Power Supply Modules
DVPPS01
DVPPS02



Electrical Specifications & Dimension



Electrical Specifications

Dimension

General Electrical Specifications

	AC	DC
Power Supply Voltage	100 ~ 240VAC (-15% ~ 10%), 50/60Hz ±5%	24VDC (-15% ~ 20%)
Fuse Capacity	2A/250VAC	2A/250VAC
Spike Voltage Durability	1500VAC (Primary-secondary); 1500VAC (Primary-PE); 500VAC (Secondary-PE)	
Insulation impedance	>5MΩ (all I/O point-to-ground: 500VDC)	
Noise Immunity	ESD: 8KV Air Discharge EFT: Power Line - 2KV Digital I/O 1KV Analog & Communication I/O 250V RS: 26MHz ~ 1GHz, 10V/m	
Earth	The diameter of grounding wire shall not be less than that of the wiring terminal of the power. (When many PLCs are in use at the same time, please make sure every PLC is properly grounded.)	
Operation/Storage	Storage: -25°C ~ 70°C (temperature); 5 ~ 95% (humidity) Operation: 0°C ~ 55°C (temperature); 50 ~ 95% (humidity); pollution degree 2	

Input Point Specifications

	Single Common Port Input		
	General Speed(10kHz)	Medium Speed(20kHz)	High Speed(100kHz/200kHz)
Input Signal Type	SINK / SOURCE		
Input Signal Voltage	24VDC ± 10% (5mA)		
Response time			
ES/EX	0 ~ 15ms adjustable		
SS/SA/SX	0 ~ 20ms adjustable		
SC	0 ~ 20ms adjustable		4.7μs
EH2/SV	0 ~ 60ms adjustable		3μs
Motion Level	OFF->ON	> 16.5VDC	> 18.5VDC
	ON->OFF	< 8VDC	< 8VDC

Output Point Specifications

	Relay (R)	Transistor (T)	
		General Speed	High Speed
Max. Exchange (Working) Frequency	Load ON/OFF Control	10kHz	50kHz/100kHz/200kHz
Current Specification			
ES/EX	2A	0.3A/1 point@40°C	<1kHz, 0.3A/1 point@40°C ≥1kHz, 30mA/1 point@40°C
SS	1.5A		
SA/SX/SC	1.5A		
EH2	2A		
SV	1.5A		
Voltage Specification	250VAC/30VDC	30VDC	
Response Time	10ms	OFF->ON: 20μs ON->OFF: 30μs	EH2/SV 0.5μs SC 1μs SA/SX 2μs

DVPACAB2A30 PIN Definition

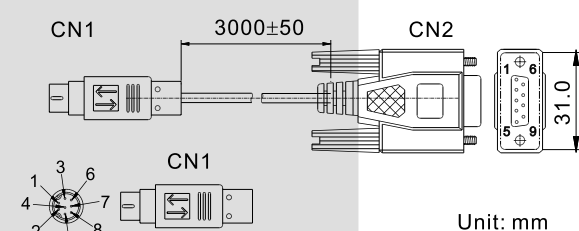

PC/HMI COM Port	PLC COM1 Port
9 PIN D-SUB female	8 PIN MINI DIN
Tx 3	Rx 4
Rx 2	Tx 5
GND 5	GND 8
	1,2 5V
1	7
4	8
6	

EH2 Series MPU

Model (mm)	H	H1	W	W1	W2
DVP16EH00R2/T2	90	80	113	103	82
DVP20EH00R2/T2	90	80	113	103	82
DVP32EH00M2	90	80	143.5	133.5	82
DVP32EH00R2/T2	90	80	143.5	133.5	82
DVP32EH00R2-L	90	80	143.5	133.5	82
DVP32EH00T2-L	90	80	143.5	133.5	82
DVP40EH00R2/T2	90	80	158.5	153.5	82
DVP48EH00R2/T2	90	80	174	164	82
DVP64EH00R2/T2	90	80	212	202	82
DVP80EH00R2/T2	90	80	276	266	82

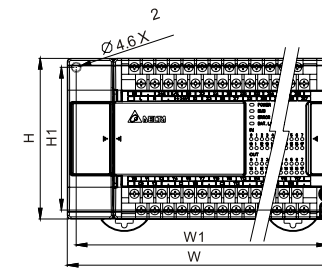

ES/EX Series I/O Extension Units

Model (mm)	H	H1	W	W1	W2
DVP08XM11N	100	95	42	37.5	82
DVP16XM11N	100	95	104	99	82
DVP08XN11R/T	100	95	42	37.5	82
DVP16XN11R/T	100	95	155	150	82
DVP24XN11R/T	100	95	155	150	82
DVP24XN00R/T	100	95	155	150	82
DVP08XP11R/T	100	95	42	37.5	82
DVP24XP11R/T	100	95	155	150	82
DVP24XP00R	100	95	155	150	82
DVP32XP00R/T	100	95	155	150	82

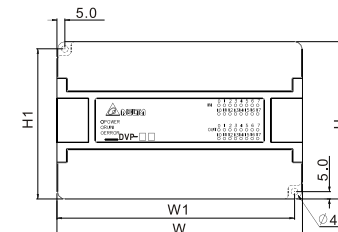

SS/SA/SX/SC Series MPU

Model (mm)	H	H1	W	W1
DVP14SS11R2/T2	96	90	25.2	60
DVP12SA11R/T	96	90	37.4	60
DVP10SX11R/T	96	90	37.4	60
DVP12SC11T	96	90	37.4	60

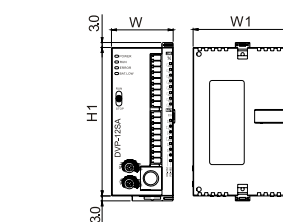

EH2 Series I/O Extension Units & Extension Modules

Model (mm)	H	H1	W	W1	W2
DVP08HM11N	90	80	40	36	82
DVP16HM11N	90	80	55	51	82
DVP08HN11R/T	90	80	40	36	82
DVP32HN00R/T	90	80	143.5	133.5	82
DVP08HP11R/T	90	80	40	36	82
DVP16HP11R/T	90	80	55	51	82
DVP32HP00R/T	90	80	143.5	133.5	82
DVP48HP00R/T	90	80	174	164	82

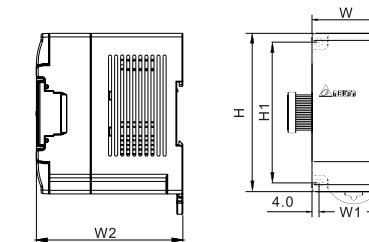

PM Series MPU

Model (mm)	H	H1	W	W1	W2
DVP20PM00D	90	80	174	164	82

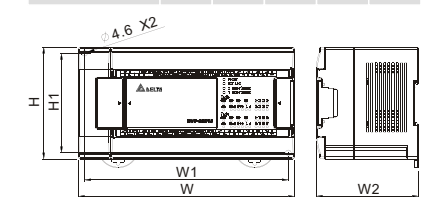

ES/EX Series MPU

Model (mm)	H	H1	W	W1	W2
DVP14ES00R2/T2	100	95	104	99	82
DVP24ES00(11)R2/T2	100	95	155	150	82
DVP30ES00R2/T2	100	95	155	150	82
DVP32ES00R2/T2	100	95	155	150	82
DVP40ES00R2/T2	100	95	155	150	82
DVP60ES00R2/T2	100	85.5	185	180.5	89.6
DVP20EX00(11)R2/T2	100	95	155	150	82

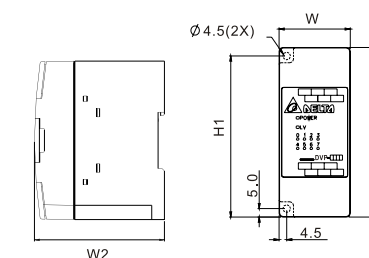

SV Series MPU

Model (mm)	H	H1	W	W1
DVP28SV11R/T	60	90	70	55

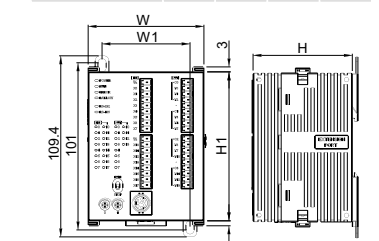

SV Left Side Extension Modules

Model (mm)	H	H1	W	W1
DVPEN01-SL	96	90	33.1	60
DVPCOPM-SL	96	90	33.1	60
DVPDNET-SL	96	90	33.1	60

Remote I/O

Model (mm)	H	H1	W	W1
RTU-DNET	96	90	25.2	60
RTU-485	96	90	25.2	60

SS/SA/SX/SC Series I/O Extension Units & Extension Modules

Model (mm)	H	H1	W	W1
DVP08SM11N	96	90	25.2	60
DVP06SN11R	96	90	25.2	60
DVP08SN11R/T	96	90	25.2	60
DVP08SP11R/T	96	95	25.2	60
DVP16SP11R/T	96	90	25.2	60
DVP04AD-S	96	90	25.2	60
DVP06AD-S	96	90	25.2	60
DVP02DA-S	96	90	25.2	60
DVP04DA-S	96	90	25.2	60
DVP06XA-S	96	90	25.2	60
DVP04PT-S	96	90	25.2	60
DVP04TC-S	96	90	25.2	60
DVP01PU-S	96	90	25.2	60
DVPPF01-S	96	90	25.2	60
DVPDT01-S	96	90	25.2	60
DVPPS01	96	90	25.2	60
DVPPS02	96	90	25.2	60

Network Structure



DVPEN01-SL

- Standard Modbus TCP
- Auto data exchange
- E-Mail alarm

DVPDNET-SL

- DeviceNet master
- Comply with international standard IEC62026-3

IFD9502

- DeviceNet conversion gateway
- Connectable to all Delta industrial automation products

RTU-DNET

- DeviceNet remote I/O module
- Connectable to DI/O and AI/O

DVPDT01-S

- DeviceNet slave module

DVPDT02-H2

- DeviceNet slave module

DVPCOPM-SL

- CANopen master module

DVPCP02-H2

- CANopen slave module

DVPPF01-S

- Profibus slave module

DVPPF02-H2

- DVPPF02-H2
- PROFIBUS slave module

IFD9506

- Ethernet conversion gateway
- As master or slave
- Connectable to all Delta industrial automation products
- Modbus TCP protocol

IFD9507

- Ethernet conversion gateway
- As master or slave
- Connectable to all Delta industrial automation products
- Ethernet IP protocol

TAP-CN01/02 TAP-CN03

- DeviceNet/CANopen distribution box

IFD9503

- CANopen conversion gateway
- Connectable to all Delta industrial automation products

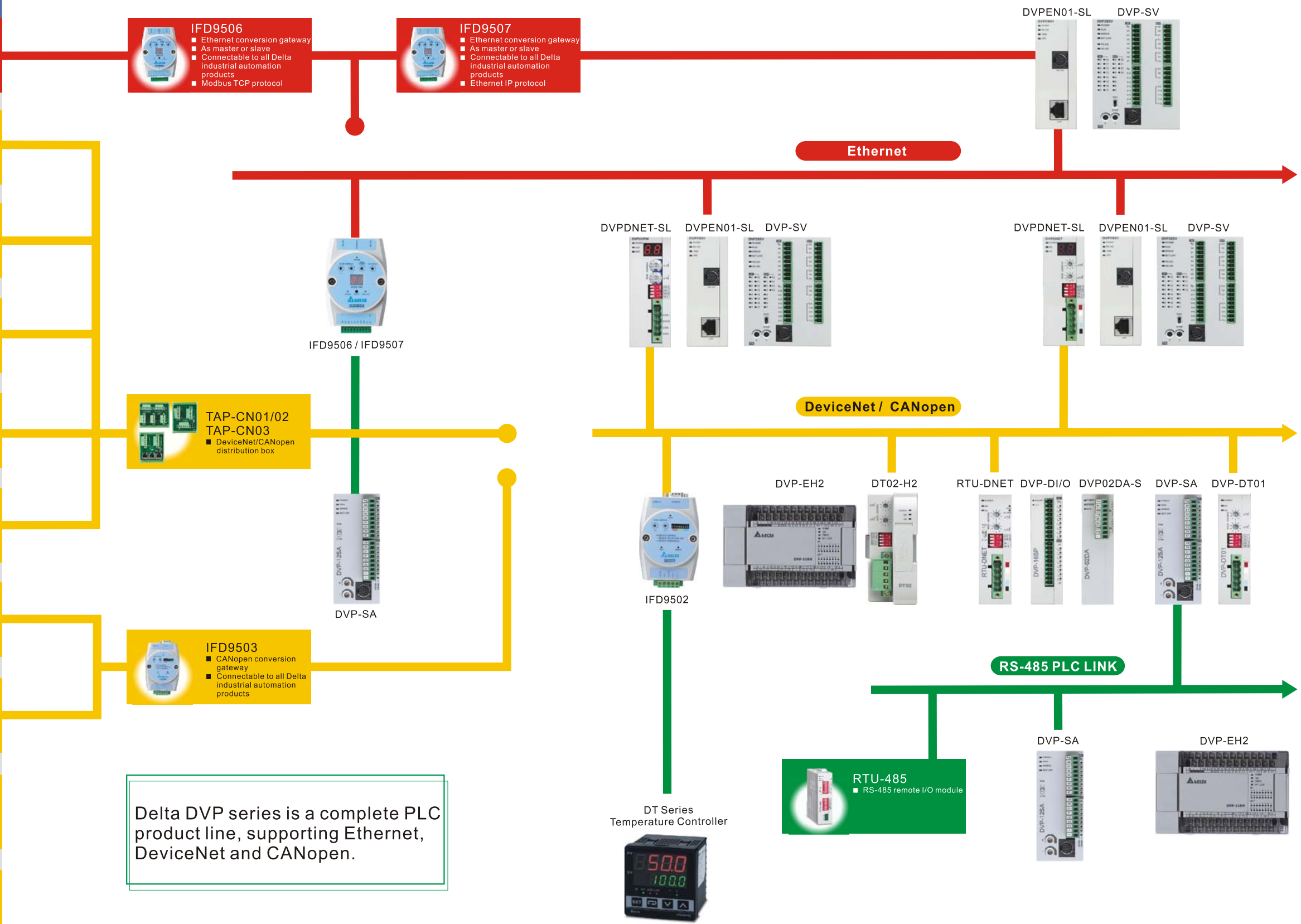

Delta DVP series is a complete PLC product line, supporting Ethernet, DeviceNet and CANopen.



Ordering Information





EH2 Series MPU



Model	Power supply	Output method	Inputs	Outputs	Model name	Standard	
EH2 standard MPU	100~240VAC	Relay (left-side extension available)	8	8	DVP16EH00R2	 	
	100~240VAC	Transistor	8	8	DVP16EH00T2		
	100~240VAC	Relay	12	8	DVP20EH00R2		
		Transistor	12	8	DVP20EH00T2		
	Built in with 2 axes of independent 200kHz pulse output						
	100~240VAC	Transistor	16	16	DVP32EH00T2		
		Built in with 2 axes of independent 200kHz pulse output					
	100~240VAC	Relay	16	16	DVP32EH00R2		
	100~240VAC	Line driver	16	16	DVP32EH00M2		
	100~240VAC	Relay(left-side extension available)	16	16	DVP32EH00R2-L		
		Transistor(left-side extension available)	16	16	DVP32EH00T2-L		
	100~240VAC	Transistor	24	16	DVP40EH00T2		
		Built in with 4 axes of independent 200kHz pulse output					
	100~240VAC	Relay	24	16	DVP40EH00R2		
	100~240VAC	Relay	24	24	DVP48EH00R2		
	100~240VAC	Transistor	24	24	DVP48EH00T2		
	100~240VAC	Relay	32	32	DVP64EH00R2		
	100~240VAC	Transistor	32	32	DVP64EH00T2		
100~240VAC	Relay	40	40	DVP80EH00R2			
100~240VAC	Transistor	40	40	DVP80EH00T2			

Execution time of basic instruction: 0.24μs Execution time of output instruction: 0.24μs



EH2 Series Extension Unit/Module

Model	Output method	Inputs	Outputs	Model name	Standard
Digital extension unit	Relay	4	4	DVP08HP11R	 
	Transistor	4	4	DVP08HP11T	
	Relay	-	8	DVP08HN11R	
	Transistor	-	8	DVP08HN11T	
	-	8	-	DVP08HM11N	
	Relay	8	8	DVP16HP11R	
	Transistor	8	8	DVP16HP11T	
	-	16	-	DVP16HM11N	
	Relay	-	32	DVP32HN00R	
	Transistor	-	32	DVP32HN00T	
	Relay	16	16	DVP32HP11R	
	Transistor	16	16	DVP32HP11T	
	Relay	24	24	DVP48HP00R	
	Transistor	24	24	DVP48HP00T	
	Analog extension module	<ul style="list-style-type: none"> 4 points of analog voltage (-10V~+10V)/current (-20mA~+20mA) input Resolution: 14 bit Photocoupler isolation Built-in RS-485 interface 			
<ul style="list-style-type: none"> 4 points of analog voltage (0V~+10V)/current (0mA~+20mA) output Resolution: 12 bit Photocoupler isolation Built-in RS-485 interface 			DVP04DA-H2		
<ul style="list-style-type: none"> 4 points of analog voltage (-10V~+10V)/current (-20mA~+20mA) input 2 points of analog voltage (0V~+10V)/current (0mA~+20mA) output Resolution: 12 bit No isolation Built-in RS-485 interface 			DVP06XA-H2		

EH2 Series Extension Unit/Module

Model	Output method	Inputs	Outputs	Model name	Standard
Temperature measurement module	<ul style="list-style-type: none"> 4 points of platinum temperature sensor (Pt100) input Resolution: 0.1°C Photocoupler isolation Built-in RS-485 interface 			DVP04PT-H2	 
Temperature measurement module	<ul style="list-style-type: none"> 4 points of thermocouple temperature sensor (K, J type) input Resolution: 0.1°C Photocoupler isolation Built-in RS-485 interface 			DVP04TC-H2	
Positioning module	Single-axis 200kHz servo positioning control			DVP01PU-H2	
High-speed counter module	1CH high-speed counter			DVP01HC-H2	
Communication module	ROFIBUS DP slave communication module			DVPPF02-H2	
	CANopen industrial network slave module			DVPCP02-H2	
	DeviceNet industrial network slave module			DVPDT02-H2	
Function card	RS-232 communication port conversion (COM2)			DVP-F232	
	RS-422 communication port conversion (COM2)			DVP-F422	
	RS-232 communication port (COM3) extension			DVP-F232S	
	RS-485 communication port (COM3) extension			DVP-F485S	
	<ul style="list-style-type: none"> 2 points of analog voltage (0V~+10V)/current (0mA~+20mA) input Resolution: 12 bit No isolation 			DVP-F2AD	
	<ul style="list-style-type: none"> 2 points of analog voltage (0V~+10V)/current (0mA~+20mA) output Resolution: 12 bit No isolation 			DVP-F2DA	
	4 points of digital input			DVP-F4IP	
	2 points of transistor output			DVP-F2OT	
	8 points of digital input DIP switch			DVP-F8ID	
	6 points of analog input rotary switch			DVP-F6VR	
	Frequency measurement card			DVP-F2FR	
	Digital display panel	Displaying registers, RTC and so on			DVPDU01

ES/EX Series MPU



Model	Power supply	Output method	Inputs	Outputs	Model name	Standard
ES standard MPU	100~240VAC	Relay	8	6	DVP14ES00R2	 
	100~240VAC	Transistor	8	6	DVP14ES00T2	
	100~240VAC	Relay	16	8	DVP24ES00R2	
	100~240VAC	Transistor	16	8	DVP24ES00T2	
	100~240VAC	Relay	18	12	DVP30ES00R2	
	100~240VAC	Transistor	18	12	DVP30ES00T2	
	100~240VAC	Relay	16	16	DVP32ES00R2	
	100~240VAC	Transistor	16	16	DVP32ES00T2	
	100~240VAC	Relay	24	16	DVP40ES00R2	
	100~240VAC	Transistor	24	16	DVP40ES00T2	
	100~240VAC	Relay	24	24	DVP48ES00R2	
	100~240VAC	Transistor	24	24	DVP48ES00T2	
	100~240VAC	Relay	36	24	DVP60ES00R2	
	100~240VAC	Transistor	36	24	DVP60ES00T2	
EX analog MPU	100~240VAC	Relay	8	6	DVP20EX00R2	
		Analog	4	2	DVP20EX00T2	
	100~240VAC	Transistor	8	6	DVP20EX00T2	
		Analog	4	2	DVP20EX00T2	
	24VDC	Relay	8	6	DVP20EX11R2	
		Analog	4	2		

Execution time of basic instruction: 3.8μs Execution time of output instruction: 5.04μs





Ordering Information





ES/EX Series Extension Unit

Model	Output method	Inputs	Outputs	Model name	Standard
Digital extension unit	-	8	-	DVP08XM11N	 
	Relay	-	8	DVP08XN11R	
	Transistor	-	8	DVP08XN11T	
	-	16	-	DVP16XM11N	
	Relay	-	16	DVP16XN11R	
	Transistor	-	16	DVP16XN11T	
	Relay	-	24	DVP24XN11R	
	Transistor	-	24	DVP24XN11T	
	Relay	4	4	DVP08XP11R	
	Transistor	4	4	DVP08XP11T	
	Relay	16	8	DVP24XP11R	
	Transistor	16	8	DVP24XP11T	
	Transistor	16	8	DVP24XP00R	
	Relay	-	24	DVP24XN00R	
	Transistor	-	24	DVP24XN00T	
	Relay	16	16	DVP32XP00R	
	Transistor	16	16	DVP32XP00T	
	Relay	16	16	DVP32XP11R	
Transistor	16	16	DVP32XP11T		





S Series MPU

Model	Power supply	Output method	Inputs	Outputs	Model name	Standard
SS standard type	24VDC	Relay	8	6	DVP14SS11R2	 
	24VDC	Transistor	8	6	DVP14SS11T2	
SA advanced type	24VDC	Relay	8	4	DVP12SA11R	
	24VDC	Transistor	8	4	DVP12SA11T	
SX analog type	24VDC	Relay	6	4	DVP10SX11R	
		Analog	2	2		
	24VDC	Transistor	6	4	DVP10SX11T	
		Analog	2	2		
SC positioning type	24VDC	Transistor	8	4	DVP12SC11T	
Execution time of basic instruction		3.8μs	Execution time of output instruction		5.04μs	
SV extension type	24VDC	Relay	16	12	DVP28SV11R	 
	24VDC	Transistor	16	12	DVP28SV11T	
Execution time of basic instruction		0.24μs	Execution time of output instruction		0.24μs	



S Series Extension Unit/Module

Model	Output method	Inputs	Outputs	Model name	Standard
SS/SA/SX/SC/SV digital extension unit	Relay	-	6	DVP06SN11R	 
	Relay	-	8	DVP08SN11R	
	Transistor	-	8	DVP08SN11T	
	Relay	4	4	DVP08SP11R	
	Transistor	4	4	DVP08SP11T	
	-	8	-	DVP08SM11N	
	-	8	-	DVP08SM10N	
	Digital switch	8	-	DVP08ST11N	
	Relay	8	8	DVP16SP11R	

S Series Extension Unit/Module

Model	Output method	Inputs	Outputs	Model name	Standard
SS/SA/SX/SC/SV digital extension unit	Transistor	8	8	DVP16SP11T	 
	Transistor (PNP)	8	8	DVP16SP11TS	
	-	16	-	DVP16SM11N	
	Transistor (pin-headed)	-	32	DVP32SN11TN	
	Pin-headed	32	-	DVP32SM11N	
SS/SA/SX/SC/SV analog extension module	<ul style="list-style-type: none"> 4 points of analog voltage (-10V~+10V)/ current (-20mA~+20mA) input Resolution: 14 bit Photocoupler isolation Built-in RS-485 interface 			DVP04AD-S	 
	<ul style="list-style-type: none"> 4 points of analog voltage (0V~+10V)/ current (0mA~+20mA) output Resolution: 12 bit Photocoupler isolation Built-in RS-485 interface 			DVP04DA-S	
	<ul style="list-style-type: none"> 2 points of analog voltage (0V~+10V)/ current (0mA~+20mA) output Built-in RS-485 interface 			DVP02DA-S	
	<ul style="list-style-type: none"> 6 points of analog voltage (-10V~+10V)/ current (-20mA~+20mA) input Resolution: 14 bit Photocoupler isolation Built-in RS-485 interface 			DVP06AD-S	
	<ul style="list-style-type: none"> 2 points of analog voltage (-10V~+10V)/ current (-20mA~+20mA) input 2 points of analog voltage (0V~+10V)/ current (0mA~+20mA) output Resolution: 12 bit No isolation Built-in RS-485 interface 			DVP06XA-S	
	<ul style="list-style-type: none"> 4 points of platinum temperature sensor (PT100) input Resolution: 0.1°C Photocoupler isolation Built-in RS-485 interface 			DVP04PT-S	
SS/SA/SX/SC temperature measurement module	<ul style="list-style-type: none"> 4 points of thermocouple temperature sensor (K, J type) input Resolution: 0.1°C Photocoupler isolation Built-in RS-485 interface 			DVP04TC-S	
SS/SA/SX/SC/SV positioning module	Single-axis 200kHz servo positioning control			DVP01PU-S	
SS/SA/SX/SC/SV communication module	DeviceNet industrial network slave module			DVPDT01-S	
	PROFIBUS DP industrial network slave module			DVPPF01-S	
24VDC power supply module	100~240VAC power supply, 24VDC/1A output			DVPPS01	
	100~240VAC power supply, 24VDC/2A output			DVPPS02	
SV left-side high-speed extension module	Ethernet module, Modus TCP, 10/100Base TX			DVPEN01-SL	
	DeviceNet master module, 500kbps			DVPDNET-SL	
	CANopen master module, 1Mbps			DVPCOPM-SL	
Remote I/O	DeviceNet remote I/O module, connectable to S series extension unit			RTU-DNET	
	RS-485 remote I/O module, connectable to S series extension unit			RTU-485	
	Ethernet remote I/O module, connectable to S series extension unit			RTU-EN01	

PM Series MPU

Model	Power supply	Output method	Inputs	Outputs	Model name	Standard
Professional motion control MPU	100~240VAC	Differential	8	8	DVP20PM00D	 
		Built in with 2 axes of independent 500kHz pulse output				
Execution time of basic instruction		3.3μs	Execution time of output instruction		3.74μs	

Ordering Information



Industrial Network Converter

Model	Detail	Model Name	Standard
Ethernet converter	Ethernet (Modbus TCP) to RS-232, RS-485 converter	IFD9506	
Ethernet converter	Ethernet (Ethernet IP) to RS-232, RS-485 converter	IFD9507	
DeviceNet converter	CANopen to RS-232, RS-485 converter	IFD9502	
CANopen converter	DeviceNet to RS-232, RS-485 converter	IFD9503	
RS-232/RS-485, 422 converter	RS-232 to RS-422/485 isolated converter	IFD8500	
RS-485/RS-422 repeater	RS-232/RS-422/485 isolated repeater	IFD8510	
RS-232/RS-485, 422 converter	RS-232 to RS-422/485 isolated converter. The user can indicate the address.	IFD8520	

DIN Rail Power Supply

Model	Power supply	Input	Output	Model Name	Standard
CliQ series	1-phase	85~264VAC/ 120~375VDC	24V 60W	DRP024V060W1AZ (Plastic)	 GS, CSA
		85~264VAC/ 120~375VDC	24V 60W	DRP024V060W1AA (Aluminum)	
		85~264VAC/ 120~375VDC	24V 120W	DRP024V120W1AA (Aluminum)	 GS
		85~264VAC/ 120~375VDC	24V 240W	DRP024V240W1AA (Aluminum)	
		85~264VAC/ 120~375VDC	24V 480W	DRP024V480W1AA (Aluminum)	
	3-phase	320~575VAC/ 450~800VDC	24V 60W	DRP024V060W3AA (Aluminum)	 GS
		320~575VAC/ 450~800VDC	24V 120W	DRP024V120W3AA (Aluminum)	
		320~575VAC/ 450~800VDC	24V 240W	DRP024V240W3AA (Aluminum)	
		320~575VAC/ 450~800VDC	24V 480W	DRP024V480W3AA (Aluminum)	
		320~575VAC/ 450~800VDC	24V 480W	DRP024V480W3AA (Aluminum)	

Accessories

Model	Detail	Model name	Standard
Peripherals & accessories	DVP series handheld programming panel	DVPHPP03	
	Data back-up card (one is built-in in DVPHPP02)	DVP-256FM	
	Data back-up card	DVP-PCC01	
	Communication cable for DVPHPP03 and PLC, 1.5m	DVPACAB115	
	Communication cable for PC (9 Pin & 25 Pin D-Sub) and PLC, 1.5m	DVPACAB215	
	Communication cable for PC (9 Pin D-Sub) and PLC, 1.5m	DVPACAB2A30	
	Communication cable (9 Pin & 25 Pin D-Sub) and PLC, 3m	DVPACAB230	
	Connection cable for DVP32SM	DVPACAB7A10	
	Connection cable for DVP32SN	DVPACAB7B10	
	Drive board for DVP32SM (32 points of input)	DVPAETB-ID32A	
	Drive board for DVP32SN (16 points of output)	DVPAETB-OR16A	
	Communication cable for DVPHPP03 and PC, 1.5m	DVPACAB315	
	Supports 4 types of RS-485 connectors	ADP485-01	
	Communication cable for ADP485-01 and ASD-A, 30cm	ADPCAB03A	
	Communication cable for ADP485-01 and ASD-B, 30cm	ADPCAB03B	
	Extension cable for ES/EX series I/O extension unit, 30cm	DVPACAB403	
	Extension connector for EH series MPU and extension modules	DVPAEXT01-H	
	Extension cable for EH series MPU and extension modules, 0.9m	DVPACAB4A09	
	Extension cable for EH series MPU and extension modules, 1.8m	DVPACAB4A18	
	DeviceNet/CANopen distribution box, 1 for 2	TAP-CN01	
	DeviceNet/CANopen distribution box, 1 for 4	TAP-CN02	
	DeviceNet/CANopen distribution box, 1 for 4, RJ45 connector	TAP-CN03	
	3.6V Lithium battery (unchargeable) for EH/SA/SX series MPU	DVPABT01	

Software

Model	Detail
WPLSoft	Windows-based Editing Software for DVP series PLC on Windows 98, Me, NT4.0, 2000, XP, or Vista
PMSoft	Editing software for PM series MPU Programming Tool for PM series MPU (Windows 2000 / XP)
DeviceNetBuilder	DeviceNet configuration software
CANopenBuilder	CANopen configuration software
DMT	VB, VC DLL library for DVP series PLC





■ ***Siège social &
service technique :***

Z.A Ahuy-Suzon
17 rue des grandes Varennes
B.P 46 - 21121 AHUY
Tél : 03 80 55 00 00
fax : 03 80 53 93 63

infos@transtechnik.fr

www.transtechnik.fr

■ ***Bureau Paris :***

12 avenue des Andes
Bâtiment A
91967 COURTABOEUF Cedex
Tél: 03 80 55 00 00
Fax: 03 80 53 93 63

■ ***Bureau Lyon :***

Espace Florentin
71 chemin du moulin Carron
69570 DARDILLY
Tél: 03 80 55 00 00
Fax: 03 80 53 93 63