

intelligence

AUTOMATES PROGRAMMABLES SERIE DVP-ES2

m o t i o n
la force de la gamme !



transtechnik
servomécanismes

DVP-ES2

The Perfect Small PLC Revolution!



16ES2

8 points of digital input
8 points of digital output



20EX2

8 points of digital input, 4 points of analog input
6 points of digital output, 2 points of analog output



24ES2

16 points of digital input
8 points of digital output



32ES2

16 points of digital input
16 points of digital output



40ES2

24 points of digital input
16 points of digital output



60ES2

36 points of digital input
24 points of digital output

Built-in 3 serial COM ports

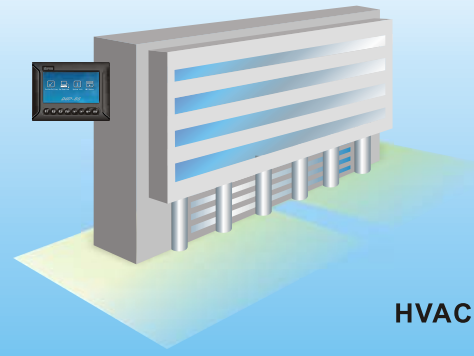

HVAC

Built-in analog I/O :
4 points of analog Input, 2 points
of analog output



Molding injection machine

16k steps: Large program
capacity



Complicated
programmable control

2-axis 100kHz pulse output

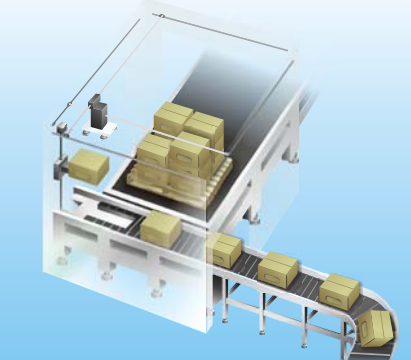

Packaging machine

Highly efficient
instruction operation

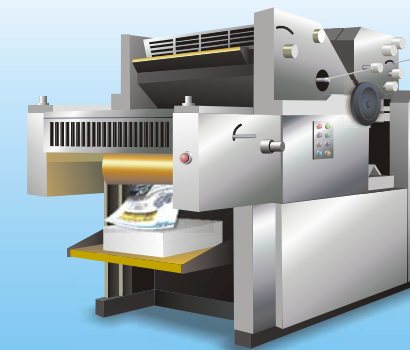

Printing machine

2 points of 100kHz
high-speed input



Inspection system

I/O Modules



DVP-ES2 MPU



Digital Input Modules



Digital Output Modules



Temperature Measurement Modules



Digital I/O Modules



Analog I/O Modules



ES2/EX2 Series

Specifications

Model name	20EX200T 20EX200R	16ES200T 16ES200R	24ES200T 24ES200R	32ES200T 32ES200R	40ES200T 40ES200R	60ES200T 60ES200R
High-speed input	2 points of 100kHz; 6 points of 10kHz; Max. 8 points for single-phase input; Max. 4 points for 2-phase 2-inputs					
Pulse output	2 points of 100kHz; 2 points of 10kHz					
High-speed comparison interruption	8 points					
External input interruption	8 points					
COM port	Built-in 1 RS-232 port, 2 RS-485 ports					
Built-in analog I/O	Yes	No				
AC motor drive/ Servo drive control commands	Yes					
Extension module connection	Connectable to 8 analog extension modules					
Motion control instructions	Yes, with S-curve acceleration/deceleration function					
Program execution speed	Execution speed of basic instructions: 0.35 ~ 1 μ s					
Program capacity	16k steps					
Function block editing	Yes					
Password protection	Restriction on incorrect password entry, subroutine password and PLC ID					
Max. I/O points	256 input points + 16 output points, or 256 output points + 16 input points					



Enhanced Program Execution Speed

Enhanced Extension I/O Refresh Speed

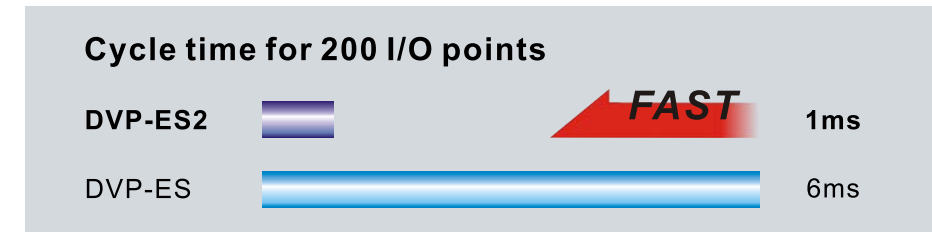

The refresh speed of extension I/O on DVP-ES2 has been greatly enhanced. Only 5 μ s is required to refresh one I/O point and 1ms for 200 I/O points, which improves the operation efficiency of the PLC.

Enhanced Program Execution Speed

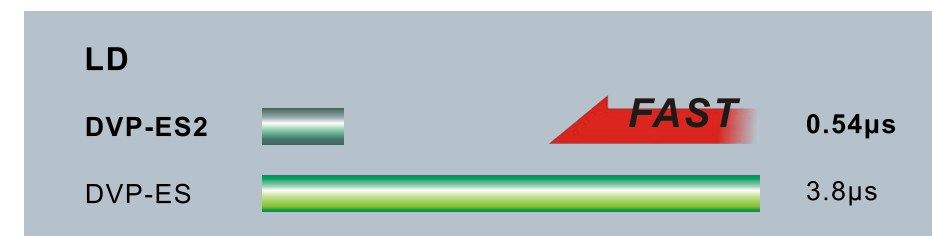

The execution speed of basic instruction LD has been enhanced to 0.54 μ s, which is a big improvement on the instruction operation efficiency.

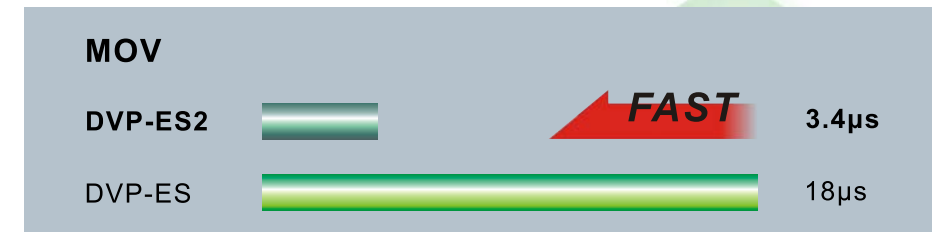

16-bit data movement instruction

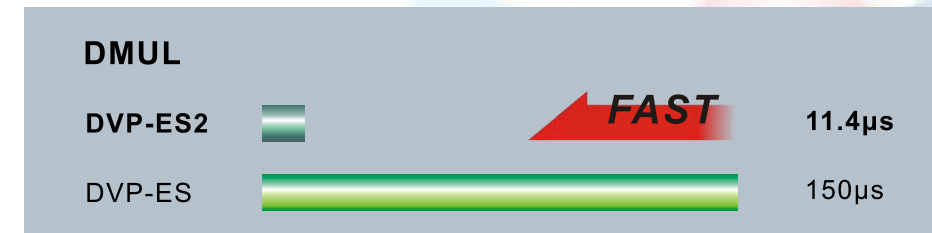

32-bit multiplication instruction

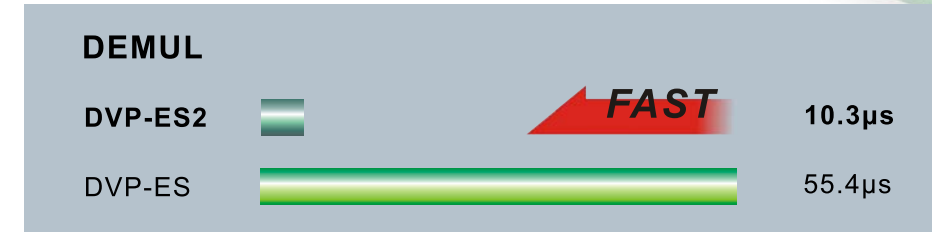

32-bit floating point multiplication instruction

The execution speed of application instructions has been greatly enhanced, allowing more complicated program operation.

High-Speed Input

DVP-ES2 is built-in with 8 points of high-speed input (2 points of 100kHz, 6 points of 10kHz) and supports U/D, U/D Dir and A/B counting modes.

Counting mode	Counting pulse	
	Up (+1)	Down (-1)
1-phases 2 inputs (U/D, DIR)		
1-phase 2 inputs (U, D)		
2-phase 2 inputs (A, B)		

Set up A/B counting mode to double frequency or 4 times frequency in special register (D1022).

D1022	Counting diagram
Double frequency (k2)	
4 times frequency (Default:k4)	

Hardware High-Speed Counters

Input	1-phase 1 inputs		1-phase 2 inputs						2-phase 2 inputs			
	C243	C244	C245	C246	C247	C248	C249	C250	C251	C252	C253	C254
X0	U		U/D	U/D	U	U			A	A		
X1	R		Dir	Dir	D	D			B	B		
X2		U					U/D	U/D			A	A
X3		R					Dir	Dir			B	B
X4				R		R				R		
X5								R				R

Pulse Output

DVP-ES2 is built-in with 4 axes of pulse output (2 points of 100kHz, 2 points of 10kHz) and supports Pulse, Pulse/Dir, A/B and CW/CCW modes.

Input	D1220				D1221			
	K0	K1	K2	K3	K0	K1	K2	K3
Y0	Pulse		Pulse	A	CW			
Y1		Pulse	Dir	B				
Y2					Pulse	Pulse	A	CCW
Y3					Pulse	Dir	B	

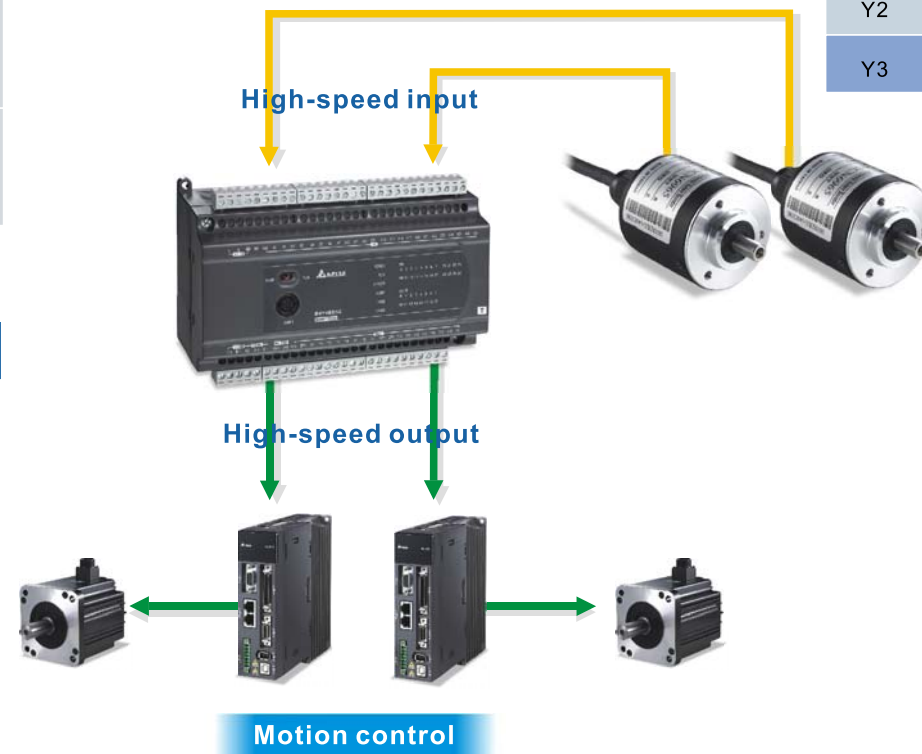

High-Speed Comparison Interruption

Use DHSCS or DHSCR high-speed comparison instructions to achieve real-time interruption once the high-speed counter reaches the counting target.

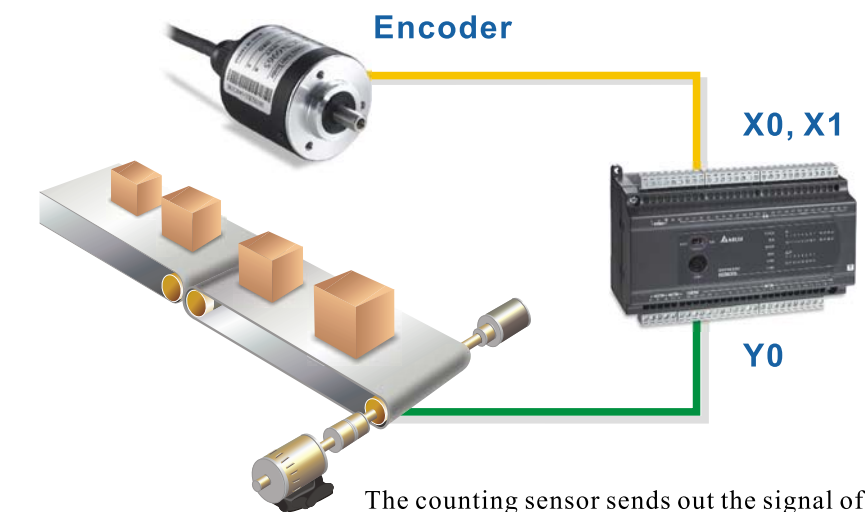

The counting sensor sends out the signal of the object currently passing through to the high-speed input points on DVP-ES2. The high-speed comparison interruption instructions are able to execute the next step once the counter reaches the assigned number.

DVP-ES2 is built-in with 2 sets of hardware counters and 4 hardware comparators for each set.

Hardware counters	A				B			
	A1	A2	A3	A4	B1	B2	B3	B4
Counter #	C243, C245-C248, C251, C252				C244, C249, C250, C253, C254			
High-speed comparison interruption	I010	I020	I030	I040	I050	I060	I070	I080
High-speed comparator	4 A comparators				4 B comparators			

Built-in 3 Serial COM Ports

DVP-ES2 is built-in with 1 RS-232 port and 2 RS-485 ports. The ports can operate together. DVP-ES2 can be Master or Slave and supports Delta Q-Link protocol to enhance the speed of HMI screen display.

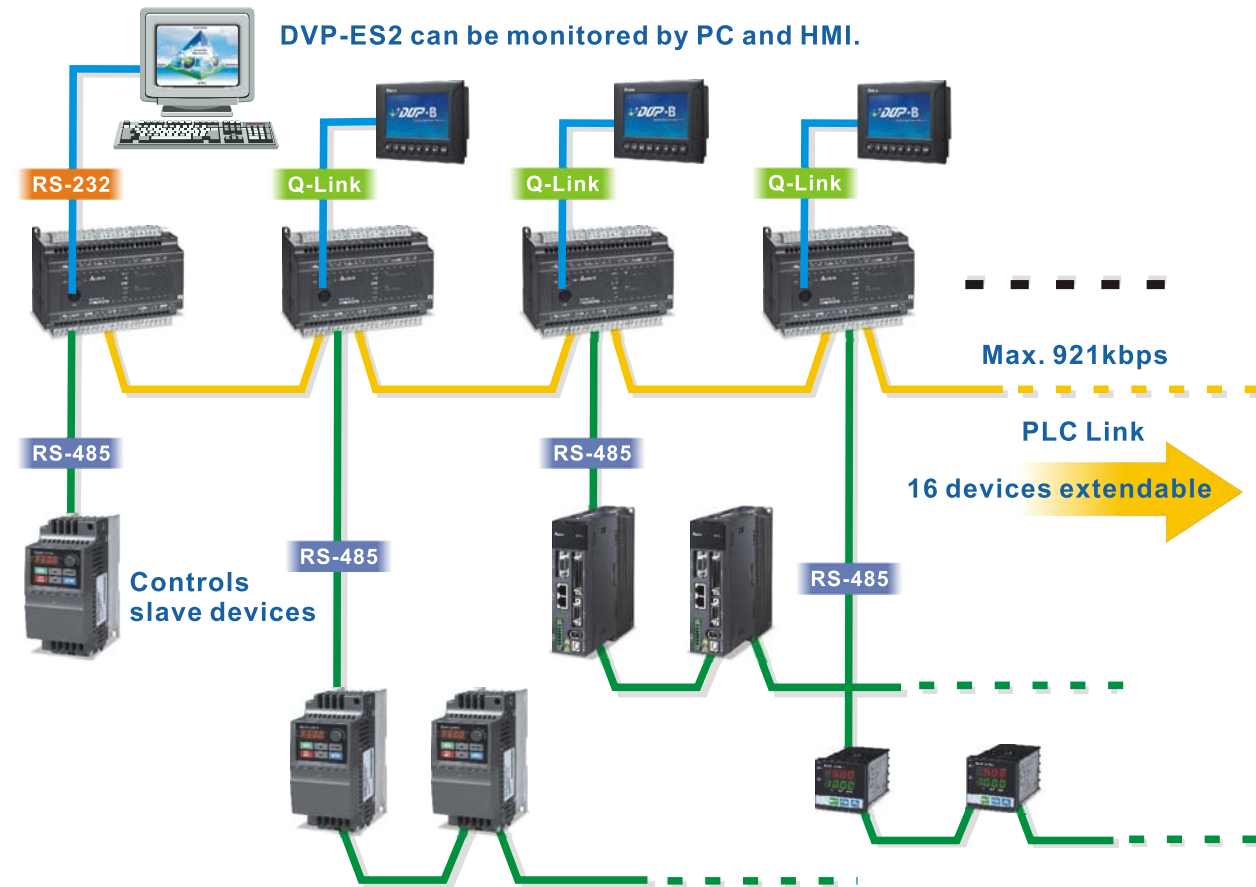

The 3 serial ports built in DVP-ES2 are able to construct a complex multi-layer network structure, increasing the system flexibility.

Built-in Analog I/O in 20EX2 Models

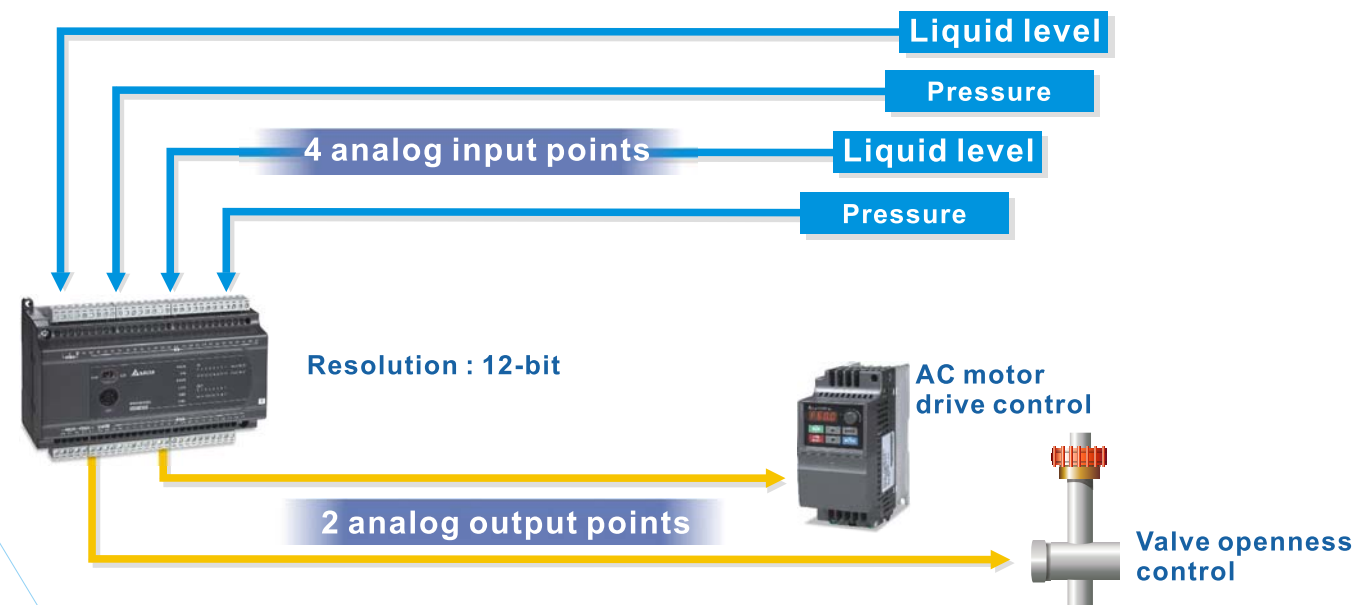

Motion Control Instructions

Variable High-Speed Pulse Output

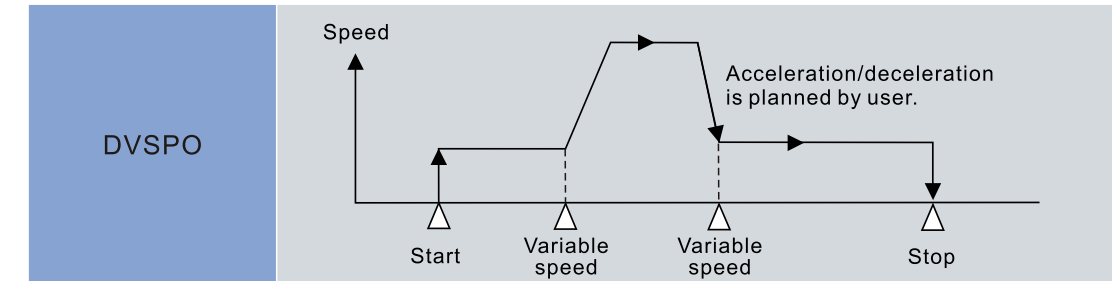

Immediate Frequency Change

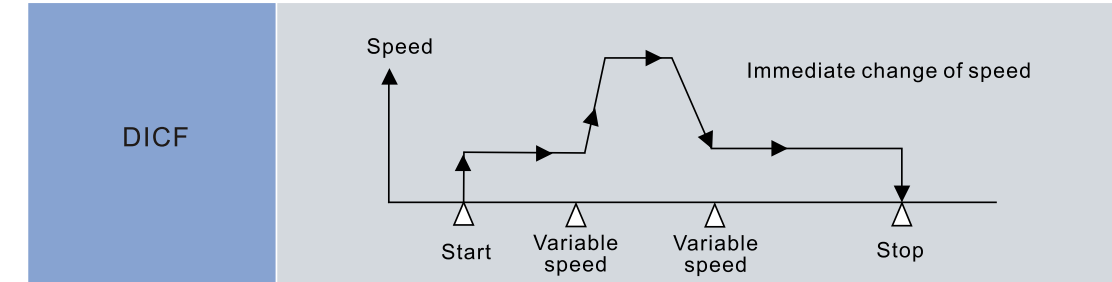

Mask Function

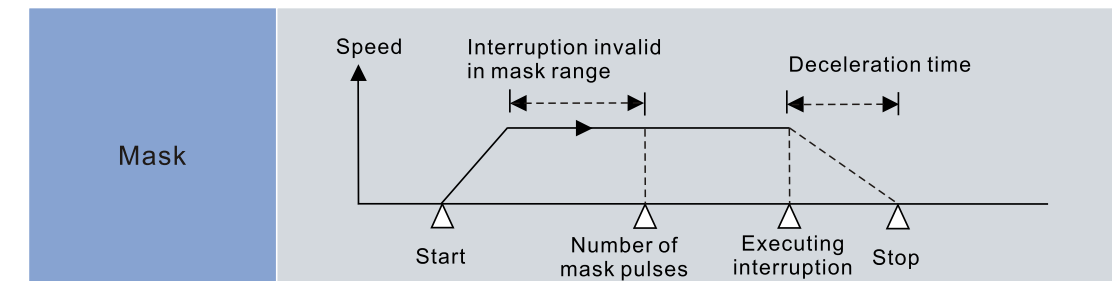

Alignment Mark

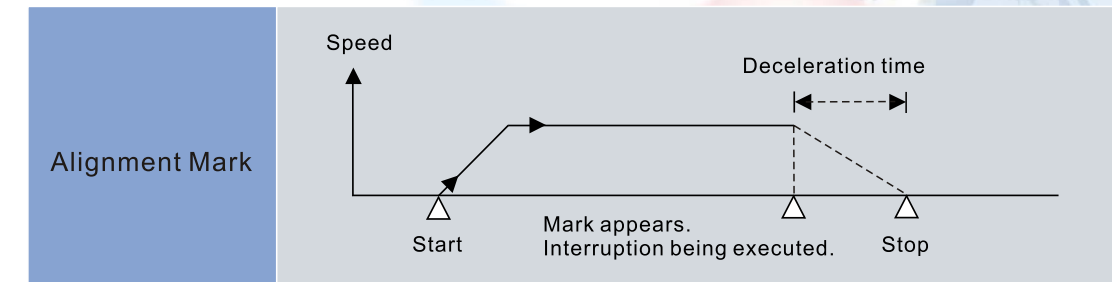

Zero Return Instruction Searching for Zero Point Automatically

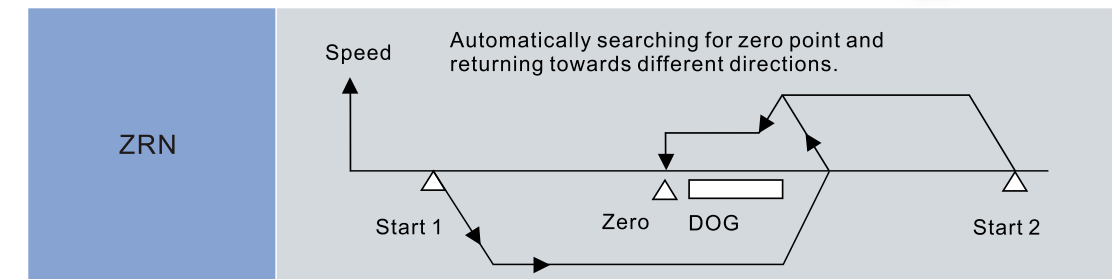

Close Loop Positioning

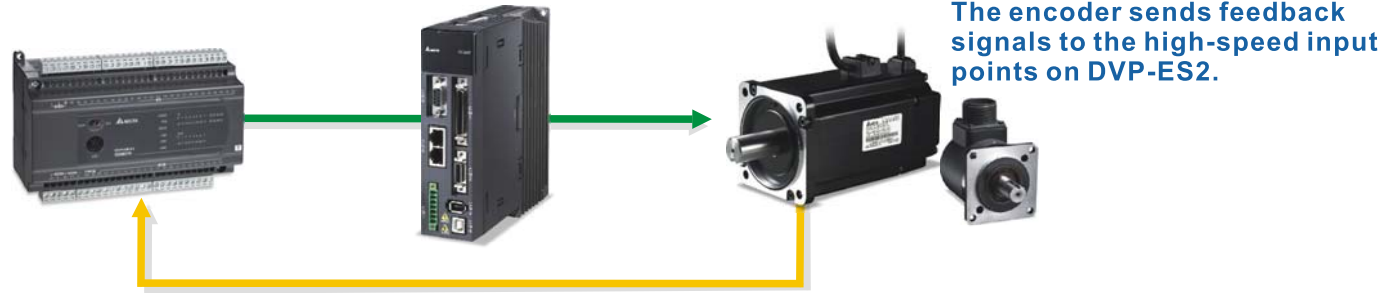

The close loop positioning instruction compares the encoder feedback signal with the PLC pulse output instruction and decides whether to set up the same number of output pulses. Compensation will be made if difference occurs to ensure correct number of output pulses.

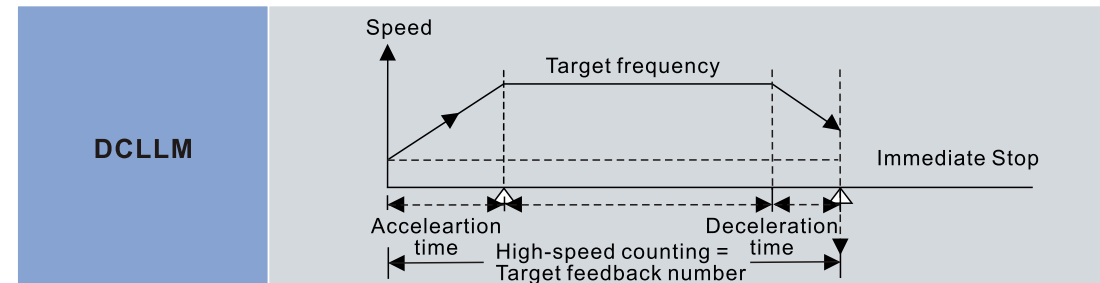
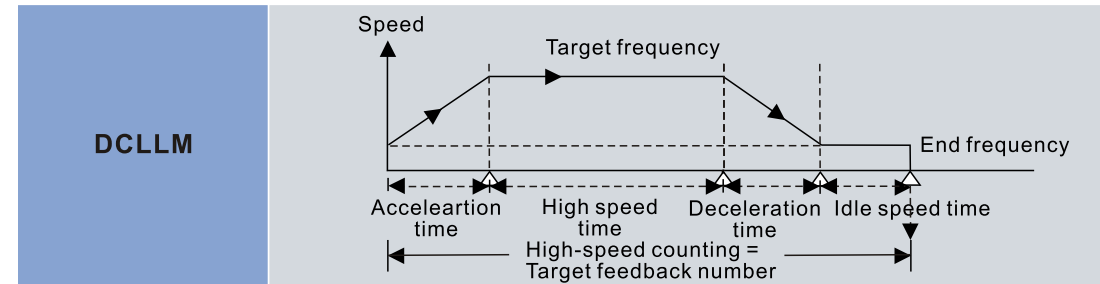

Tabulated Pulse Output

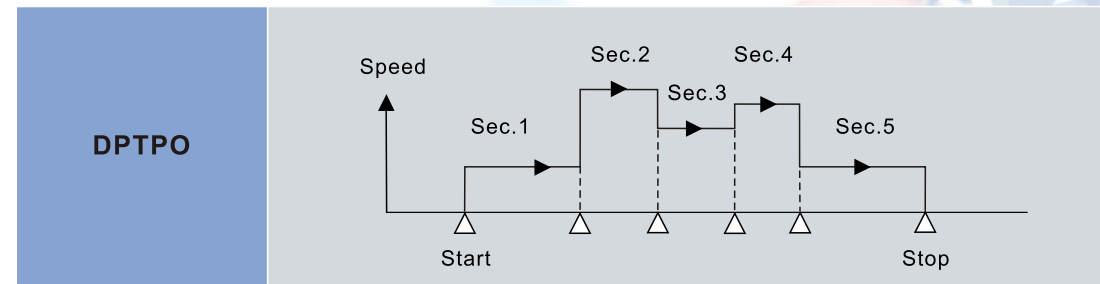

Absolute/Relative Positioning

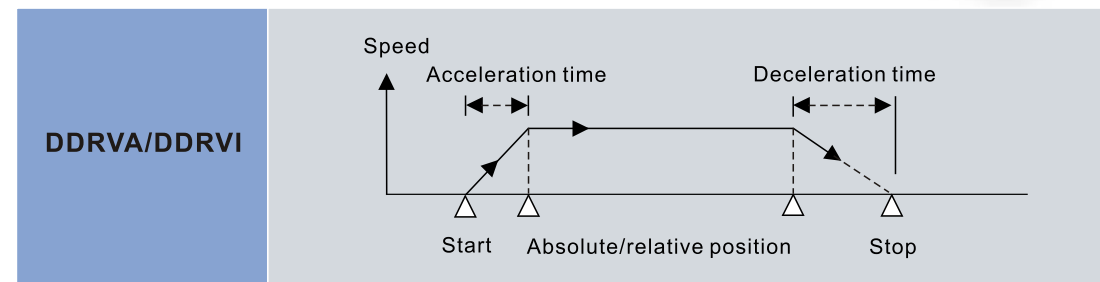

Delta's AC Motor Drive / Servo Drive

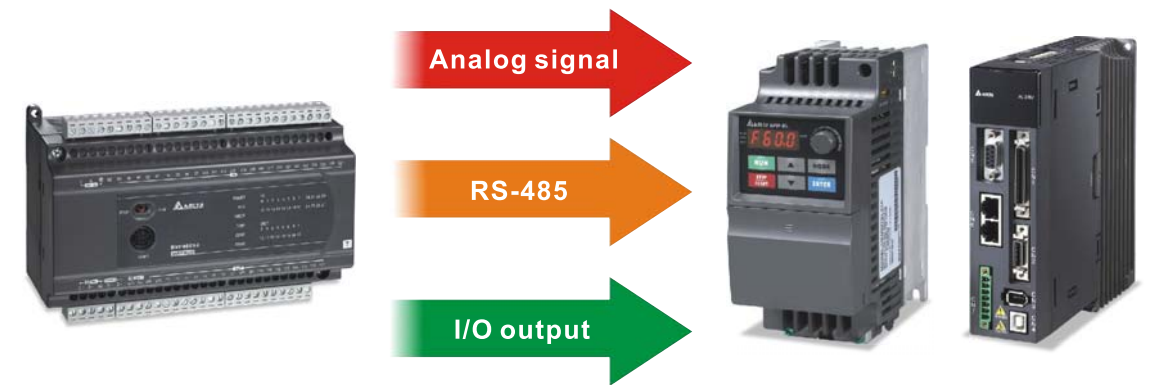

Analog signal → DVP-ES2 is able to control AC motor drive or Servo drive through output current and analog voltage signals output from the analog module.

RS-485 → DVP-ES2 has new instructions designed particularly for the communication with Delta's AC motor drives and Servo drives.

AC motor drive	FWD	REV	STOP	RSTEF	RDST
Function	Forward running	Reverse running	Stop	Reset	Read status
Servo drive	ASDRW				
Function	Read Status, read/write data, speed and position instruction				

I/O output → Use output points on DVP-ES2 to set up the multi-function input terminals on AC motor drive or Servo drive for conducting multi-section positioning.

Highly Functional Analog Module

- All analog modules are of 14-bit resolution.
- The temperature measurement modules support PID auto-tuning.

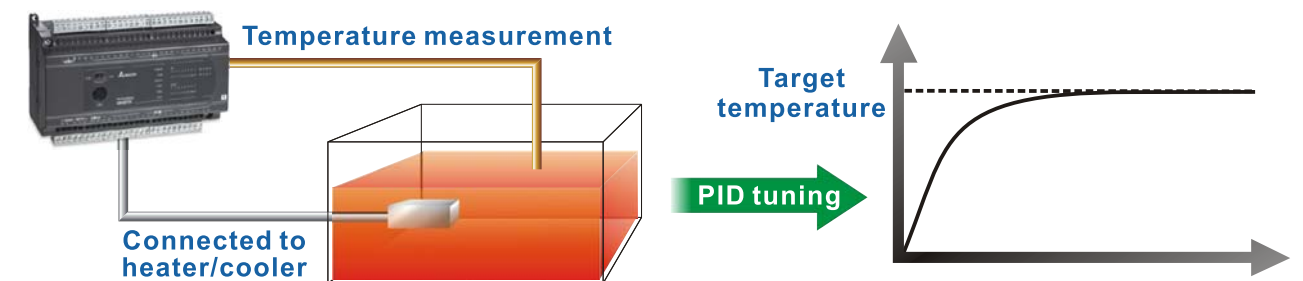

DVP04PT-E2 and DVP04TC-E2 temperature measurement modules are built in with PID function, allowing PID tuning to be directly conducted in the module to reduce the PLC load and achieve better overall efficiency.

Password Protection

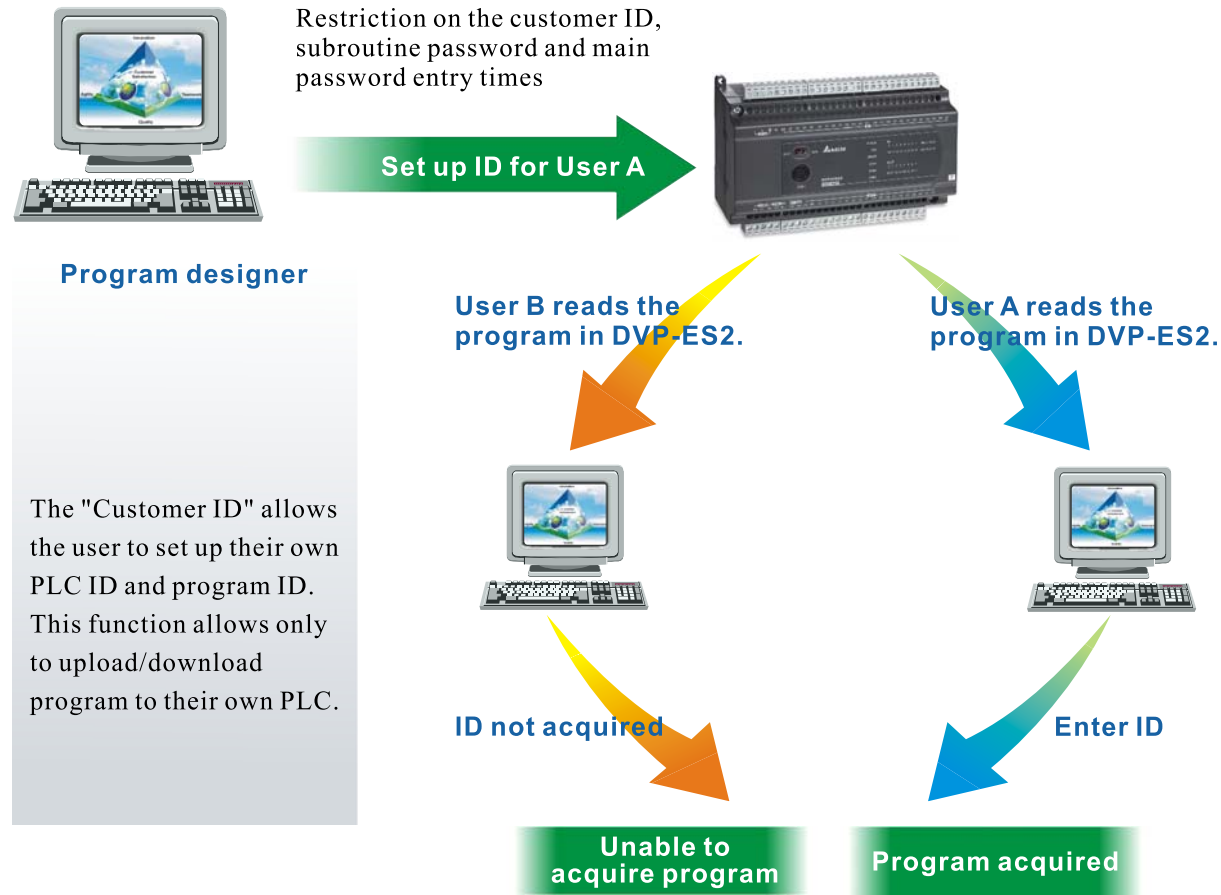

Subroutine Password & PLC ID

The subroutine password and ID can be 4 ~ 8 digits.

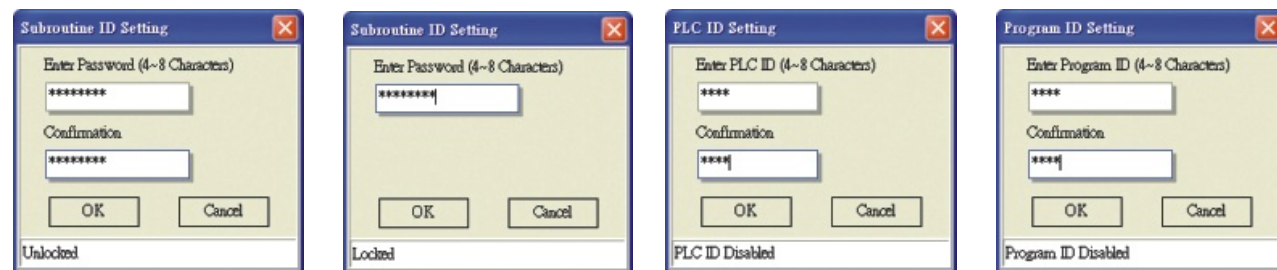

The number of allowed incorrect entries of main password can be set up.



Enhanced Instruction Application

SPA & GPS support solar tracker

The 2 instructions working with GPS can effectively achieve the highest efficiency for the solar tracker.

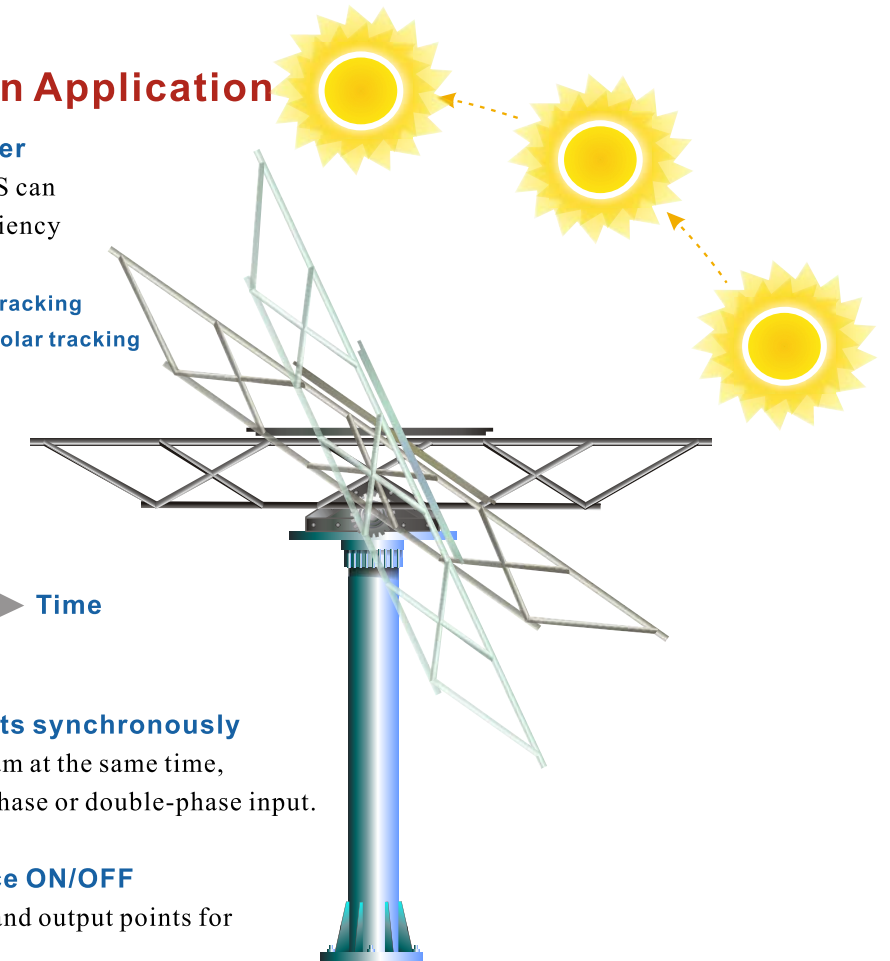
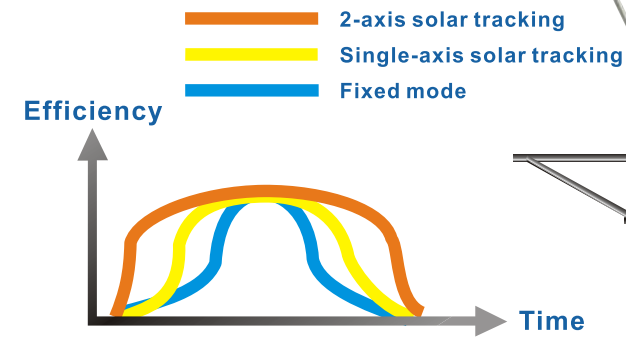

SPD able to detect 4 input points synchronously

Use 4 SPD instructions in the program at the same time, and each instruction can be single-phase or double-phase input.

Input X & output Y support force ON/OFF

Use software to force control input and output points for trial run and debug.

Extension Module Connection

Flexible Mapping Mode

All the setting up and reading of the parameters in DVP-ES2 can be done easily in the software. Every analog/digital or digital/analog value in the analog module corresponds directly to a special D device in DVP-ES2. The user does not need to use FROM/TO instructions as before.

In the past, you needed to compile programs to read/write the value.

Now, you only need to modify or read the corresponding register in DVP-ES2.

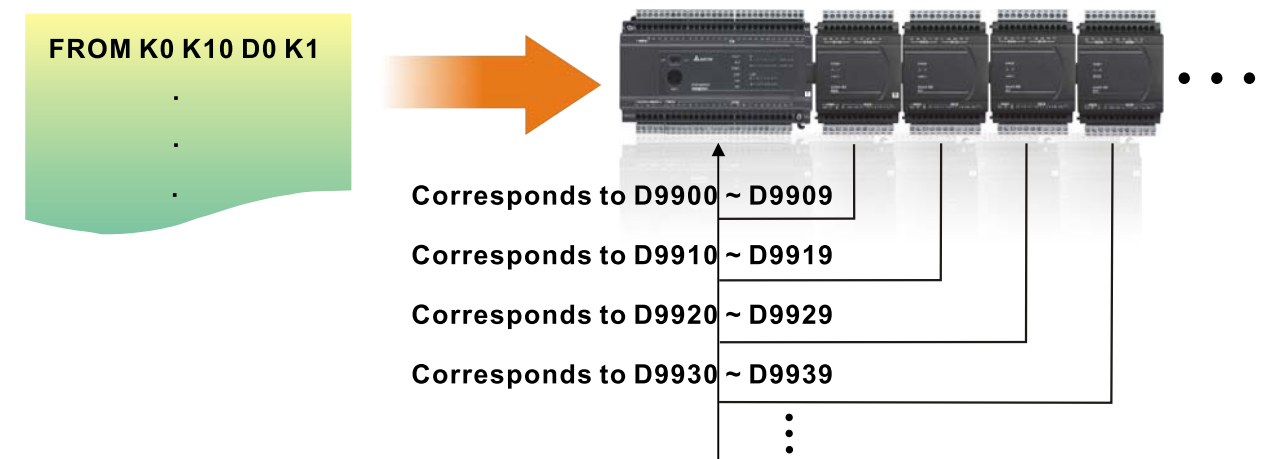

The New Programming Software: ISPSoft

The New Programming Software: ISPSoft supports ladder diagram, function block and many other programming modes and is able to edit program in modular way. ISPSoft saves your time in developing large projects. Use the already made function block over and over again to increase your economical benefit. ISPSoft is compatible with all DVP series PLCs.

Task Designation

The entire program is divided into many program units (POU), including programs and function blocks. The compiled POU can only be operated under designated condition (TASK) to control the execution of PLC.

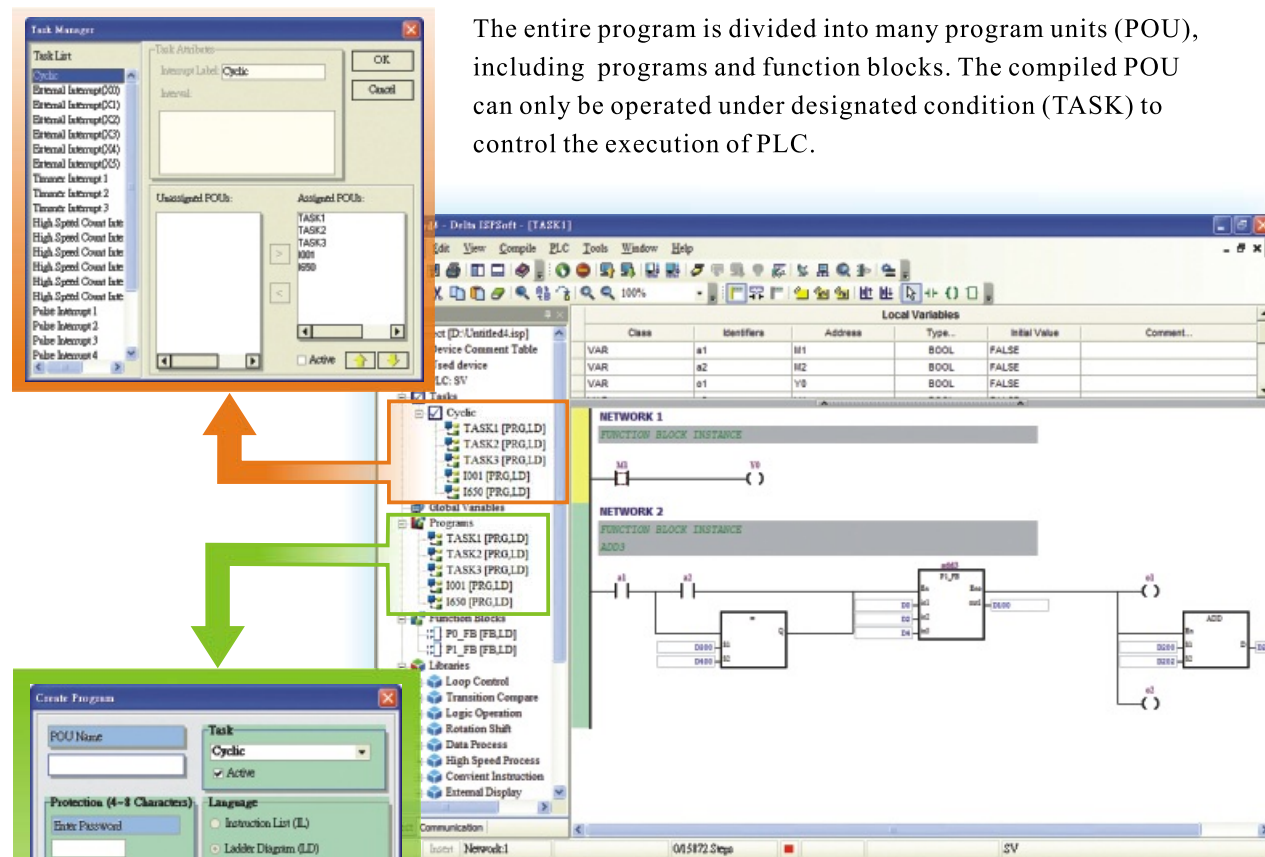

To create new cyclic or interruption programs, you have to create new POU and designate TASK first. Undesignated POU will not be executed.

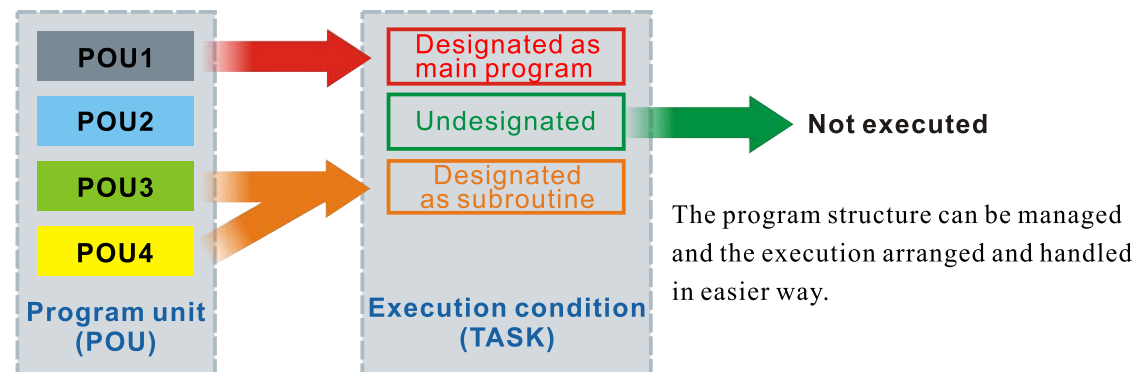
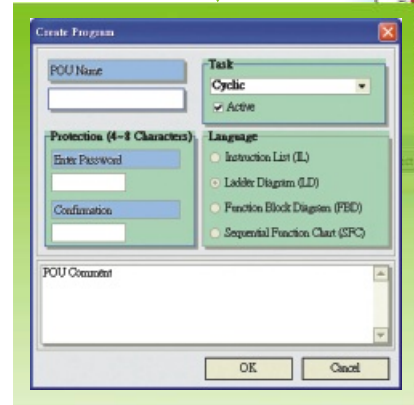

Function Block

The complicated project can be parted to many program units or function blocks. The function block can be used repeatedly.

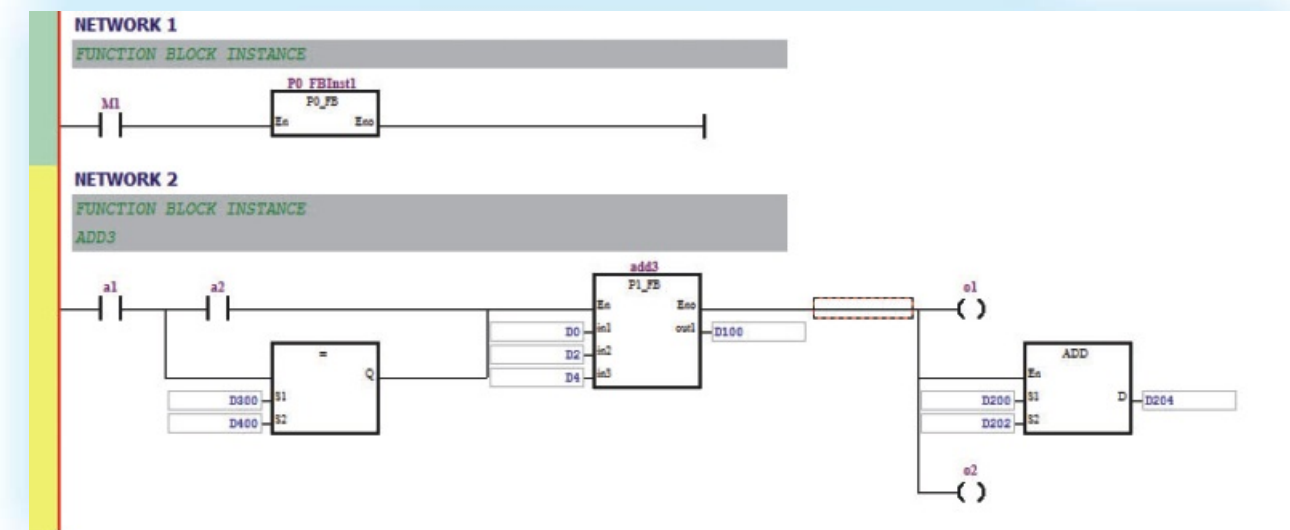
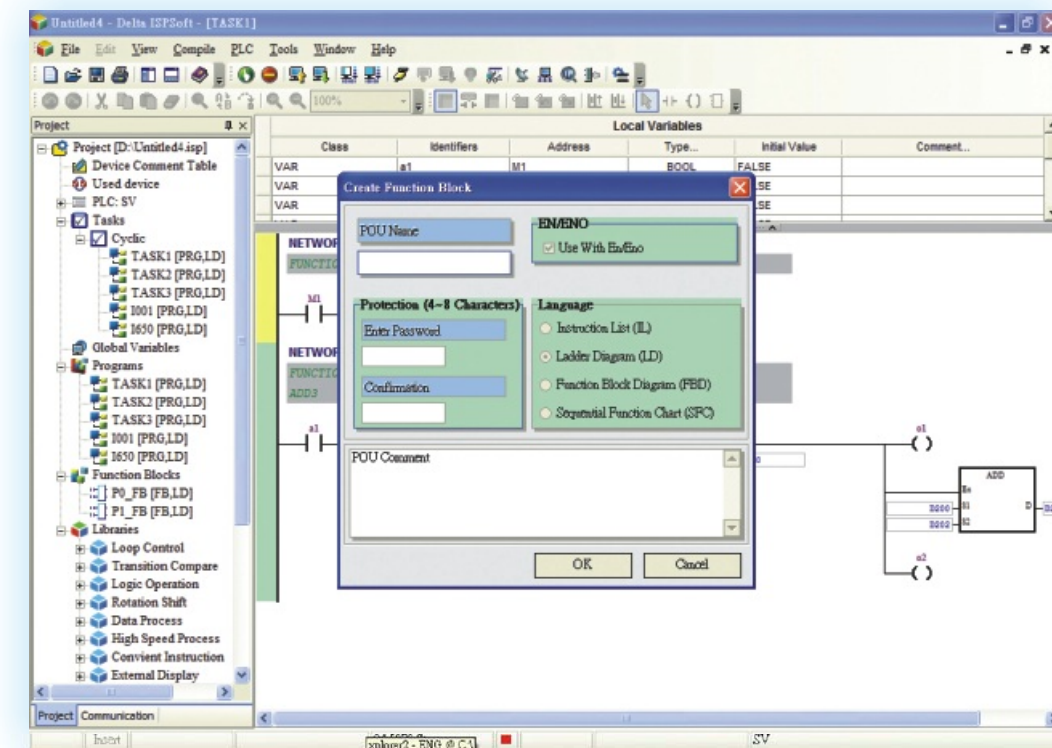

The function block can be made and used freely in the program. Use import/export function to apply the block in different programs. Particularly when many programs require the same function, the function block helps increase the efficiency of program editing.

The New Programming Software: ISPSoft

Function Block Import/Export

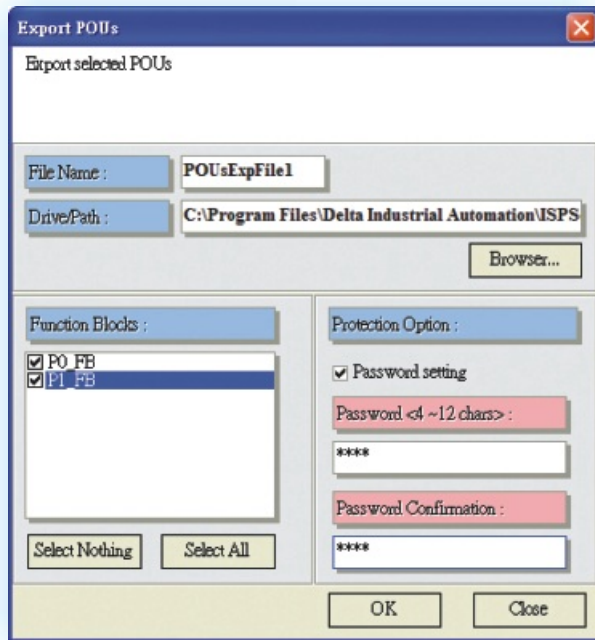

Password Protection

The user can set up password for each function block. When the block is used in other programs, the password is required to open the editing window of the block.

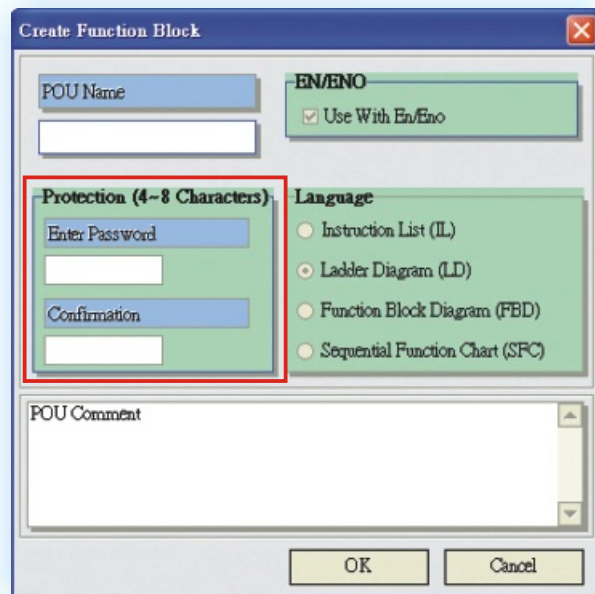

Variable Declaration

Global variable: Separate form the program. The corresponding physical I/O point of the variable is defined only after the program is compiled. The user does not need to modify the program when the definition of the physical I/O point is changed. Only the device corresponding to the variable needs to be modified.

Local variable: Stored in POU. If the user does not give it a device, the system will automatically allocate a device to the variable when compiling.

When writing the function block, it is suggested that the variable be configured by the system itself to increase the independency of the block.

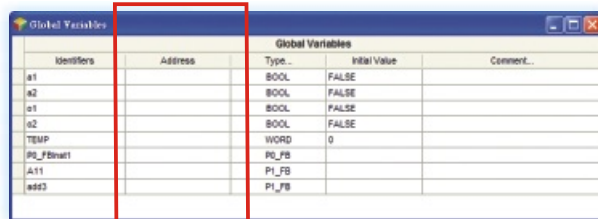

Identifiers	Address	Type...	Initial Value	Comment...
st1		BOOL	FALSE	
st2		BOOL	FALSE	
st3		BOOL	FALSE	
st4		BOOL	FALSE	
TEMP		WORD	0	
PL_Fbstart		PL_FB		
A11		PI_FB		
add3		PI_FB		

Designate corresponding physical I/O points

Device List

The device list helps the user to know clearly all the devices used in the program.

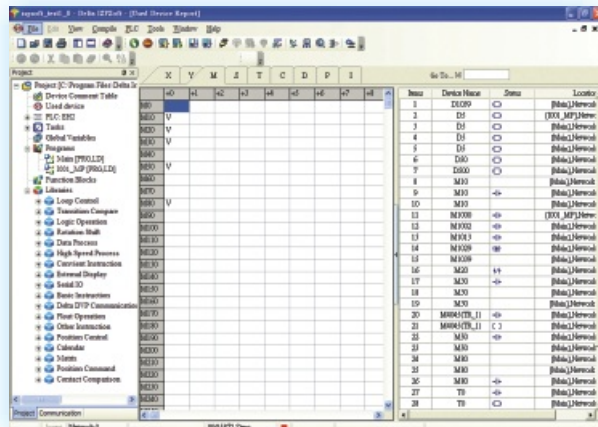

Name	Address	Type	Comment	Location
st1	D000	BOOL		BitAddress
st2	D001	BOOL		BitAddress
st3	D002	BOOL		BitAddress
st4	D003	BOOL		BitAddress
TEMP	D004	WORD		WordAddress
PL_Fbstart	D005	PL_FB		PLFbAddress
A11	D006	PI_FB		PIFbAddress
add3	D007	PI_FB		PIFbAddress

Structural Editing

Every section of the program is composed of many networks. ISPSoft provides many kinds of components for the user to drag for use.

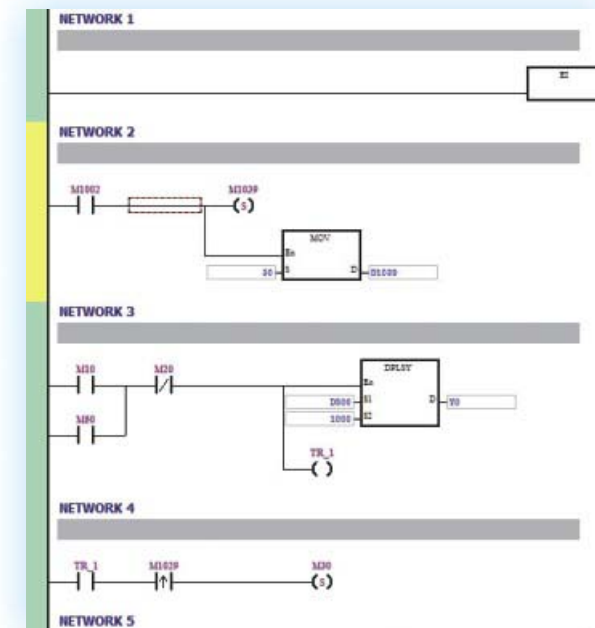

The user can enable/disable every network to trial run or debug the program and clarify the program structure.

Flexible Use of Components

Drag the components in the function library to use for editing.

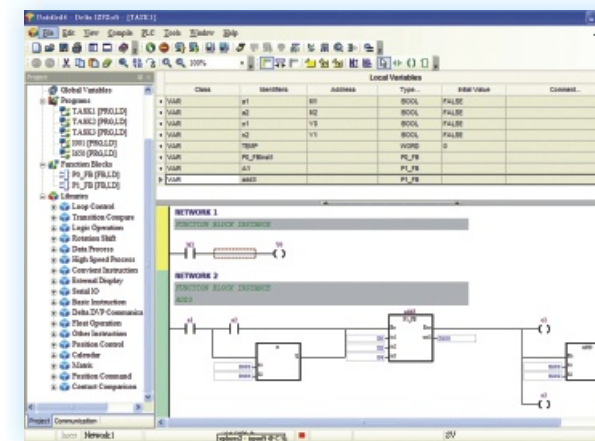

Complete Monitoring

The "Program monitoring" and "Device monitoring" allow the user to keep track of the operation of program.

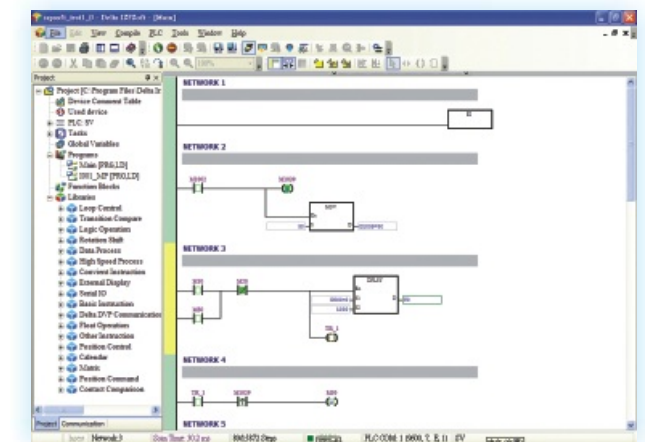
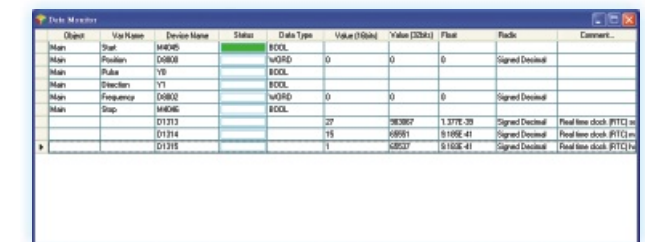
Group	Variable Name	Device Name	Status	Data Type	Value (Global)	Value (Local)	Unit	Scale	Comment...
Input	st1	D000	ON	BOOL					Signal Decoded
Input	st2	D001	OFF	BOOL					Signal Decoded
Input	st3	D002	ON	BOOL					Signal Decoded
Input	st4	D003	OFF	BOOL					Signal Decoded
Input	TEMP	D004	0.0000	WORD					Signal Decoded
Input	PL_Fbstart	D005	PL_Fbstart	PL_FB					Signal Decoded
Input	A11	D006	A11	PI_FB					Signal Decoded
Input	add3	D007	add3	PI_FB					Signal Decoded

Compatible with WPLSoft

The user can convert the file edited in WPLSoft to be compatible with ISPSoft.

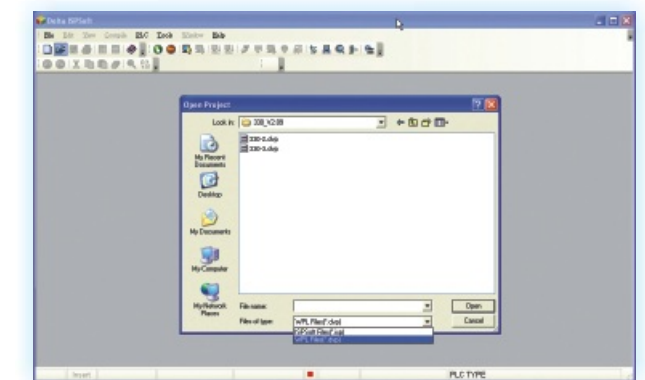

Devices, Electrical Specifications

I/O Configuration for MPU

Model	DVP 16ES200□*1	DVP 20EX200□*1	DVP 24ES200□*1	DVP 32ES200□*1	DVP 40ES200□*1	DVP 60ES200□*1	Extension I/O
Input X	X0~X7 (8 points)	X0~X7 (8 points)	X0~X17 (16 points)	X0~X17 (16 points)	X0~X27 (24 points)	X0~X43 (36 points)	X20(X50)~X337*2
Output Y	Y0~Y7 (8 points)	Y0~Y5 (6 points)	Y0~Y7 (8 points)	Y0~Y17 (16 points)	Y0~Y17 (16 points)	Y0~Y27 (24 points)	Y20(Y30)~Y337*2
Analog input	-	4 channels (12-bit)	-	-	-	-	-
Analog output	-	2 channels (12-bit)	-	-	-	-	-

I/O Configuration for Digital Modules

Model	DVP08XM 211N	DVP08XN 211□*1	DVP08XP 211□*1	DVP16XM 211N	DVP16XN 211□*1	DVP16XP 211□*1	DVP24XN 200□*1	DVP24XP 200□*1	DVP32XP 200□*1
Input X	X20~X27 (8 points)	-	X20~X23 (4 points)*3	X20~X37 (16 points)	-	X20~X27 (8 points)	-	X20~X37 (16 points)	X20~X37 (16 points)
Output Y	-	Y20~Y27 (8 points)	Y20~Y23 (4 points)*3	-	Y20~Y37 (16 points)	Y20~Y27 (8 points)	Y20~Y47 (24 points)	Y20~Y27 (8 points)	Y20~Y37 (16 points)

*1: R refers to relay output; T refers to transistor output (channel N); S refers to transistor output (channel P). For exact launch dates of these models, consult Delta's sales representatives.

*2: DVP60ES2 starts input from X50 (output from Y30) and DVP40ES2 from X30 (output from Y20). All other models start input from X20 and output from Y20. The number of extension I/O increases by 8's multiple. Number less than 8 points are regarded as 8 points.

*3: I/O points less than 8 points are regarded as 8 points.

I/O Configuration for Analog Modules (Channels x Resolution)

Model	DVP 04AD-E2	DVP 04DA-E2	DVP 06XA-E2	DVP 02DA-E2	DVP 04TC-E2	DVP 04PT-E2
Input	AD1~4 (4CHx14-bit)	-	AD1~4 (4CHx14-bit)	-	CH1~4 (4CHx16-bit)	CH1~4 (4CHx16-bit)
Output	-	DA1~4 (4CHx14-bit)	DA1~2 (2CHx14-bit)	DA1~2 (2CHx14-bit)	-	-

Devices in MPU

Type	Device	Item	Range	Function	
Relay (bit)	X	External input relay	X0~X377, octal coding, 256 points ⁴	Total 256 points Corresponds to external input points	
	Y	External output relay	Y0~Y377, octal coding, 256 points ⁴	Corresponds to external output points	
	M	Auxiliary relay	General purpose	M0~M511, 512 points ¹ M768~M999, 232 points ¹¹ M2000~M2047, 48 points ¹¹	Total 4,096 points The contact can be switched between ON/OFF in the program.
			Latched	M512~M767, 256 points ¹² M2048~M4095, 2,048 points ¹²	
T	Timer	100ms (M1028=ON, T64~T126 =10ms)	T0~T126, 127 points ¹¹ T128~T183, 56 points ¹¹ T184~T199 for subroutine, 16 points ¹¹ T250~T255* 6 accumulative points ¹¹	Total 256 points If the timer designated by TMR instruction reaches the target, the T contact of the same number will be ON.	

Devices in MPU

Type	Device	Item	Range	Function	
Relay (bit)	T	Timer	10ms (M1038=ON, T200~T245 =1ms)	T200~T239, 40 points ¹¹ T240~T245* 6 accumulative points ¹¹	Total 256 points If the timer designated by TMR instruction reaches the target, the T contact of the same number will be ON.
			1ms	T127, 1 point ¹¹ T246~T249*, 4 accumulative points ¹¹	
	C	Counter	16-bit counting up	C0~C111, 112 points ¹¹ C112~C127, 16 points ¹² C128~C199, 72 points ¹¹	Total 255 points If the counter designated by CNT (DCNT) instruction reaches the target, the C contact of the same number will be ON.
			32-bit counting up/down	C200~C223, 24 points ¹¹ C224~C231, 8 points ¹²	
			32-bit high-speed counter	C235~C244, 1-phase 1 input, 10 points ¹² C245~C250, 1-phase 2 inputs, 6 points ¹² C232~C234, C251~C254, 2-phase 2 inputs, 7 points ¹²	
	S	Step relay	Initial	S0~S9, 10 points ¹²	Total 1,024 points Devices for step ladder diagram (SFC)
For zero return			S10~S19, 10 points (used with IST instruction) ¹²		
For latched			S20~S127, 108 points ¹²		
General purpose			S128~S911, 784 points ¹²		
		For alarm	S912~S1023, 112 points ¹²		
Register (word)	T	Present value in timer	T0~T255, 16-bit timer, 256 points	The contact of the timer will be ON when the timing reaches the target.	
	C	Present value in counter	C0~C199, 16-bit counter, 200 points C200~C254, 32-bit counter, 55 points	The contact of the counter will be ON when the counting reaches the target.	
	D	Data register	General purpose	D0~D407, 408 points ¹¹ D600~D999, 400 points ¹¹ D3920~D9899, 5,980 points ¹¹	Total 10,000 points The memory area for data storage. E, F can be used for index registers.
			Latched	D408~D599, 192 points ¹² D2000~D3919, 1,920 points ¹²	
			For special registers	D1000~D1999, 1,000 points (partly latched)	
			For special modules	D9900~D9999, 100 points ^{11 15}	
		For index registers	E0~E7, F0~F7, 16 points ¹¹		
N	For main control loop	N0~N7, 8 points	Points for main control loop		
P	For CJ, CALL instructions	P0~P255, 256 points	Position index for CJ and CALL		
Index	I	Interrupt	External interruption	I00□(X0), I10□(X1), I20□(X2), I30□(X3), I40□(X4), I50□(X5), I60□(X6), I70□(X7), 8 points (□=1, rising-edge trigger, □=0, falling-edge trigger)	Position index for interruption subroutine
			Timed interruption	I6□□, I7□□, (□□=05~99ms), 2 points	
			Interruption when high-speed counter reaches target	I010、I020、I030、I040、I050、I060、I070、I080, 8 points	
			Interruption during communication	I140(COM1)、I150(COM2)、I160(COM3) (*3), 3 points	
Constant	K	Decimal	K-32,768 ~ K32,767 (16-bit operation) K-2,147,483,648 ~ K2,147,483,647 (32-bit operation)		
	H	Hexadecimal	H0000 ~ HFFFF (16-bit operation) H00000000 ~ HFFFFFFF (32-bit operation)		

*1: Non-latched area cannot be modified.

*2: Latched area cannot be modified.

*3: COM1 is the built-in RS-232 COM port; COM2 and COM3 are the built-in RS-485 COM ports.

*4: When X input is digitally extended to 256 points, Y output can only be 16 points. When Y output is digitally extended to 256 points, X input can only be 16 points.

*5: Valid only when the MPU is connected to analog modules. Every analog module connected occupies 10 points.

Devices, Electrical Specifications

M Auxiliary Relay	Non-latched	Latched	Non-latched	Special auxiliary relay	Non-latched	Latched
	M0~M511	M512~M767	M768~M999	M1000~M1999	M2000~M2047	M2048~M4095

C Counter	16-bit counting up			32-bit counting up/down		32-bit high-speed counting up/down	
	Non-latched	Latched	Non-latched		Latched		
	C0~C111	C112~C127	C128~C199	C200~C223	C224~C231	C232~C254	

T Timer	General purpose		Subroutine	General purpose		Accumulative	
	Non-latched						
	100ms	1ms	100ms	10ms		1ms	100ms
	T0~T126	T127	T128~T183	T184	T200~T239	T240~T245	T246~T249
M1028=ON, T64~T126=10ms			T199	M1038=ON, T200~T245=1ms			

S Step relay	Initial	Zero return	General purpose		Alarm step
	Latched		Non-latched		Latched
	S0~S9	S10~S19	S20~S127	S128~S911	S912~S1023

D Register	General purpose			Special register	General purpose		For modules
	Non-latched	Latched	Non-latched	Partly latched	Latched	Non-latched	Non-latched
	D0~D407	D408~D599	D600~D999	D1000~D1999	D2000~D3919	D3920~D9899	D9900~D9999

Latched Action

Memory type	Power OFF → ON	STOP → RUN	RUN → STOP	M1031=ON	M1032=ON	Default value
Non-latched	Cleared	Unchanged	Cleared when M1033= OFF Unchanged when M1033=ON	Cleared	Unchanged	0
Latched	Unchanged			Unchanged	Cleared	0
Special M, special D index register	Initial setting	Unchanged				Initial setting

DVP-ES2 MPU

Model Item	DVP16ES200□	DVP24ES200□	DVP32ES200□	DVP40ES200□	DVP60ES200□	DVP20EX200□
Power supply voltage	100 ~ 240V AC (-15% ~ 10%) , 50/60 Hz 5%					
Operation	DVP-ES2 starts to run when the power supply rises to 95 ~ 100VAC and stops when the power supply drops to 70VAC. It continues to run for 10ms after the power supply is cut off.					
Power supply fuse	2A/250V AC					
Power consumption	30VA					
DC24V supply current	500mA					
Power supply protection	DC24V output short circuit protection					
Voltage withstand	1,500V AC (Primary-secondary) 、 1,500V AC (Primary-PE) 、 500V AC (Secondary-PE)					
Insulation resistance	> 5MW at 500VDC (between all I/O points and ground)					
Grounding	The diameter of grounding wire shall not be less than that of L, N terminal of the power supply. (When many PLCs are in use at the same time, please make sure every PLC is properly grounded.)					

Model Item	DVP16ES200□	DVP24ES200□	DVP32ES200□	DVP40ES200□	DVP60ES200□	DVP20EX200□
Noise immunity	ESD : 8 kV Air Discharge EFT : Power Line: 2kV, Digital I/O : 1kV, Analog & Communication I/O : 1kV RS : 26MHz ~ 1GHz, 10V/m					
Environment	Operation: 0°C~55°C (temperature), 50~95% (humidity), pollution degree 2 Storage: -25°C~70°C (temperature), 5~95% (humidity)					
Vibration/shock resistance	International standards: IEC61131-2, IEC 68-2-6 (TEST Fc)/ IEC61131-2 & IEC 68-2-27 (TEST Ea)					
Weight (g)	R : 377g T : 351g	R : 414g T : 387g	R : 489g T : 432g	R : 554g T : 498g	R : 696g T : 614g	R : 462g T : 442g

Input Points on DVP-ES2 MPU

Input point type	Digital input		
Input type	DC (SINK or SOURCE)		
Input current	24VDC, 5mA		
Action level	Input No.	X0,X2	X1,X3~X7 X10~X17,X20
	Off→On	> 15VDC	
On→Off	< 5VDC		
Response time	Off→On	2.5μs	20μs 10ms
	On→Off	5μs	50μs 10ms
Max. input frequency	100kHz	10kHz	50Hz
Filter time X0 ~ X7	Adjustable within 0 ~ 20ms in D1020 (Default: 10ms)		
Input impedance	4.7KΩ		

Output Points on DVP-ES2 MPU

Output point type	Relay-R	Transistor-T		
Output point No.	All	Y0 Y2	Y1 Y3	Y4~Y17, Y20 ~
Current spec.	2A/1point (5A/COM)	0.5A/1point (4A/COM)		
Voltage spec.	<250VAC, 30VDC	5 ~ 30VDC		
Max. Load	75VA (inductive)	12W/1 point (24VDC)		
	90W (resistive)			
Response time	Off→On	Approx. 10ms	2μs	20μs 100μs
	On→Off		3μs	30μs 100μs
Max. output frequency	50Hz	100 kHz	10 kHz	1kHz

Analog I/O of DVP-ES2

Items	Analog Input (A/D)		Analog Output (D/A)	
	Voltage input	Current input	Voltage output	Current output
Analog I/O range	±10V	±20mA	±10V	0~20mA
Digital conversion range	-2,000 ~ +2,000	-2,000 ~ +2,000	-2,000 ~ +2,000	0 ~ +4,000
Resolution	12-bit (5.0mV=20V/4,000)	12-bit (10.0μA=40mA/4,000)	12-bit (5.0mV=20V/4,000)	12-bit (5.0μA=20mA/4,000)
Input impedance	>1MΩ	250Ω	-	
Output impedance	-		0.5Ω or lower	
Tolerance carried impedance	-		>0.5Ω	<500Ω
Overall accuracy	Non-linear accuracy: 1% of full scale within the range of PLC operation temperature Max. deviation: 1% of full scale at 20mA and +10V			
Response time	2ms (set up in D1118) ^{#1}		2ms ^{#2}	
Absolute input range	±15V	±32mA	-	
Digital data format	2's complementary of 16-bit, 12 significant bits			
Average function	Yes (set up in D1062) ^{#3}		No	
Isolation method	No Isolation between digital and analog circuit			
Protection	Voltage output has short circuit protection, but a long period of short circuit may cause internal wire damage. The current output can be open circuit.			

#1: When the scan period is longer than the set value in D1118, the setting will follow the scan period.
#2: When the scan period is longer than 2ms, the setting will follow the scan period.
#3: When the average time is "1", the present value will be read.

Power Consumption

Model name	Max. power consumption	24VDC supply current (power)
DVP16ES200R/T	30VA	500mA (12W)
DVP24ES200R/T		
DVP32ES200R/T		
DVP40ES200R/T		
DVP60ES200R/T		
DVP20EX200R/T	20VA	100mA (2.4W)
DVP24XN200R/T		
DVP24XP200R/T	R:25VA T: 20VA	
DVP32XP200R/T		
DVP08XM211N	1.2W	無
DVP08XP211R/T	R: 1.2W T: 1W	
DVP08XN211R/T	R: 1.2W T: 0.5W	
DVP16XM211N	2.4W	
DVP16XP211R/T	R: 2.4W T: 1.6W	
DVP16XN211R/T	R: 2.4W T: 1W	
DVP04AD-E2	1W	
DVP02DA-E2	1.5W	
DVP04DA-E2	3W	
DVP06XA-E2	2.5W	
DVP04PT-E2	1.5W	
DVP04TC-E2	1.2W	

Example:
When the system is composed of 32ES200R + 08XP211R + 16XP211R + 16XN211R, the ES2 MPU can only supply 12 (1.2+2.4+2.4) = 6W.

Dimensions MPU I/O Terminal Layout

DVP16ES200R/T

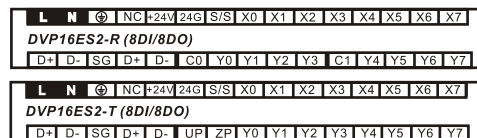

DVP24ES200R/T

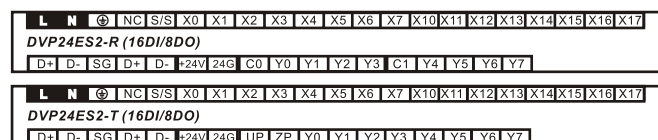

DVP32ES200R/T



DVP40ES200R/T

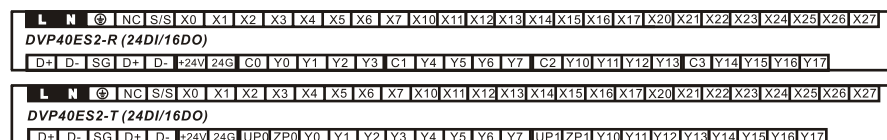

DVP60ES200R/T



DVP20EX200R/T

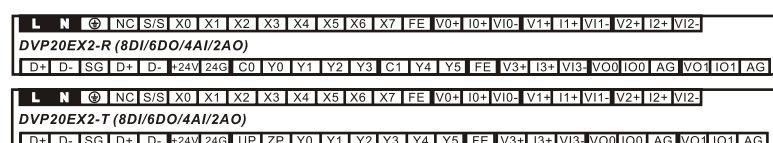

DVP-ES2/EX2 Series MPU

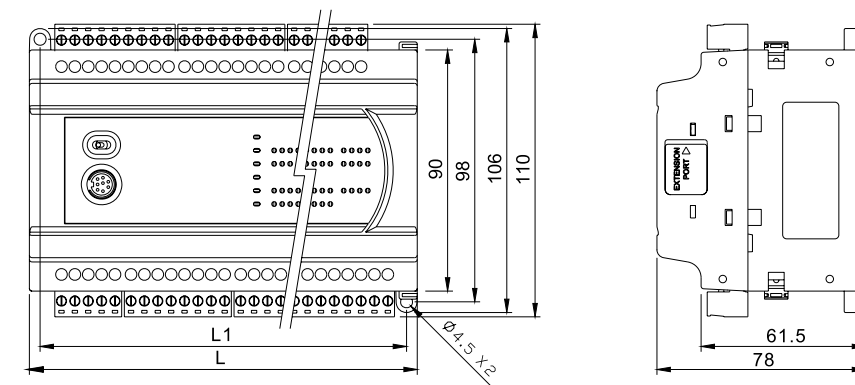

Model name	16ES200R/T	24ES200R/T	32ES200R/T	40ES200R/T	60ES200R/T	20EX200R/T
L	105	125	145	165	225	145
L1	97	117	137	157	217	137

DVP-ES2/EX2 Series Extension Modules

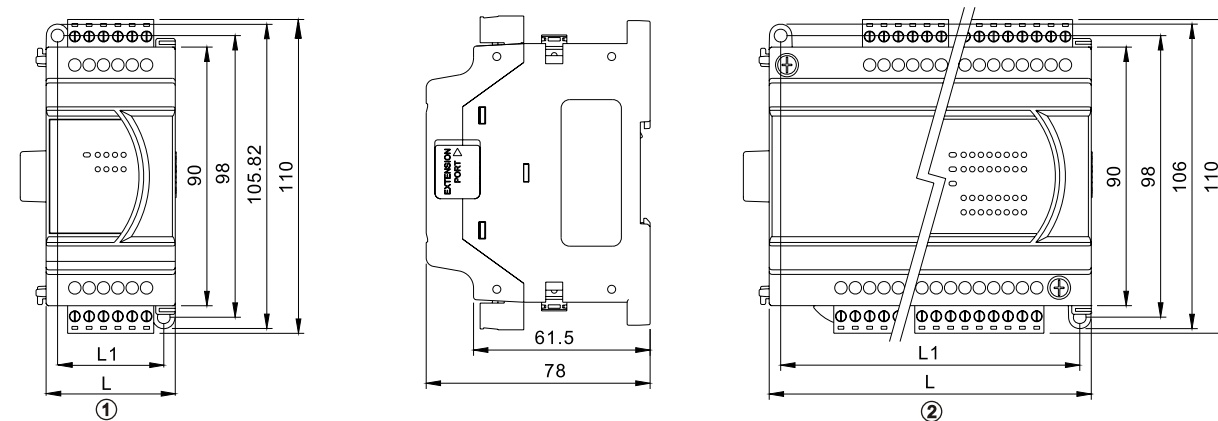





Model name	08XM2 11N	08XP2 11R/T	08XN2 11R/T	16XM2 11N	16XP2 11R/T	16XN2 11R/T	24XP2 00R/T	24XN2 00R/T	32XP2 00R/T
L		45			70			145	
L1		37			62			137	
Type		①			②			②	

Model name	04AD-E2	02DA-E2 04DA-E2	06XA-E2	04PT-E2	04TC-E2
L			70		
L1			62		
Type			②		

Ordering Information

MPU

Product name	Model name	Specification	Output method	Input points	Output points	Certificates
DVP-ES2 series Standard MPU	DVP16ES200R	Power range: 100~240VAC Max. I/O points: 272 Program capacity: 16k steps Data register: 10k words High-speed input: 2 points of 100kHz; 6 points of 10kHz Pulse output: 2 points of 100kHz; 2 points of 10kHz (Transistor output models) COM port: Built-in 1 RS-232 port and 2 RS-485 ports; compatible with Modbus ASCII/RTU protocol; can be Master or Slave	Relay	8	8	 
	DVP16ES200T		Transistor	8	8	
	DVP24ES200R		Relay	16	8	
	DVP24ES200T		Transistor	16	8	
	DVP32ES200R		Relay	16	16	
	DVP32ES200T		Transistor	16	16	
	DVP40ES200R		Relay	24	16	
	DVP40ES200T		Transistor	24	16	
	DVP60ES200R		Relay	36	24	
	DVP60ES200T		Transistor	36	24	
DVP-EX2 series Analog MPU	DVP20EX200R	Power range: 100~240VAC Max. I/O points: 272 Program capacity: 16k steps Data register: 10k words High-speed input: 2 points of 100kHz; 6 points of 10kHz Pulse output: 2 points of 100kHz; 2 points of 10kHz (Transistor output models) COM port: Built-in 1 RS-232 port and 2 RS-485 ports; compatible with Modbus ASCII/RTU protocol; can be Master or Slave Analog I/O: Built-in 12-bit 4AD/2DA	Relay	8	6	 
			Analog	4	2	
			Transistor	8	6	
	DVP20EX200T		Transistor	8	6	
			Analog	4	2	
			Analog	4	2	



Basic instruction execution time: 0.35 ~ 1μs

MOV (data movement) instruction execution time: 3.4μs







DMUL (32-bit multiplication) instruction execution time: 11.4μs

DEMUL (32-bit floating point multiplication) instruction execution time: 10.3μs

Digital I/O Modules (AC Power Supply)

Product name	Model name	Specification	Output method	Input points	Output points	Certificates
DVP-ES2/EX2 series Digital I/O Modules	DVP24XN200R	Power range: 100~240VAC	Relay	-	24	 
	DVP24XN200T		Transistor	-	24	
	DVP24XP200R		Relay	16	8	
	DVP24XP200T		Transistor	16	8	
	DVP32XP200R		Relay	16	16	
	DVP32XP200T		Transistor	16	16	

Extension Modules (24VDC Power Supply)

Product name	Model name	Output method	Input points	Output points	Certificates
DVP-ES2/EX2 series Digital I/O Modules	DVP08XM211N	-	8	-	 
	DVP08XN211R	Relay	-	8	
	DVP08XN211T	Transistor	-	8	
	DVP08XP211R	Relay	4	4	
	DVP08XP211T	Transistor	4	4	
	DVP16XM211N	-	16	-	
	DVP16XN211R	Relay	-	16	
	DVP16XN211T	Transistor	-	16	
	DVP16XP211R	Relay	8	8	
	DVP16XP211T	Transistor	8	8	
DVP-ES2/EX2 series Analog I/O Modules	DVP04AD-E2	<ul style="list-style-type: none"> 4 points of analog voltage (±10V, ±5V)/current (±20mA, 0~20mA, 4~20mA) input Resolution: 14-bit (-32,000~+32,000) Digital/analog photocoupler isolation; no isolation between channels. 			 
	DVP04DA-E2	<ul style="list-style-type: none"> 4 points of analog voltage (-10V~+10V)/current (0~20mA, 4~20mA) output Resolution: 14-bit (-32,000~+32,000)/(0~+32,000) Digital/analog photocoupler isolation; no isolation between channels. 			
	DVP02DA-E2	<ul style="list-style-type: none"> 2 points of analog voltage (-10V~+10V)/current (0~+20mA, 4~20mA) output Resolution: 14-bit (-32,000~+32,000)/(0~+32,000) Digital/analog photocoupler isolation; no isolation between channels. 			
	DVP06XA-E2	<ul style="list-style-type: none"> 4 points of analog voltage (±10V, ±5V)/current (±20mA, 0~20mA, 4~20mA) input Input resolution: 14-bit (-32,000~+32,000) 2 points of analog voltage (-10V~+10V)/current (0~20mA, 4~20mA) output Output resolution: 14-bit (-32,000~+32,000)/(0~+32,000) Digital/analog photocoupler isolation; no isolation between channels. 			
DVP-ES2/EX2 series Temperature Measurement Modules	DVP04PT-E2	<ul style="list-style-type: none"> 4 points of platinum RTD resistance (Pt100, Pt1000, Ni100, Ni1000) temperature sensor input/0~300Ω resistance input Resolution: 16-bit Digital/analog photocoupler isolation; no isolation between channels. Built-in PID temperature control 			 
	DVP04TC-E2	<ul style="list-style-type: none"> 4 points of thermocouple (J, K, R, S, T, E, N Type) temperature sensor input/-80mV~+80mV voltage input Resolution: 16-bit Digital/analog photocoupler isolation; isolations between channels. Built-in PID temperature control 			



■ ***Siège social &
service technique :***

Z.A Ahuy-Suzon
17 rue des grandes Varennes
B.P 46 - 21121 AHUY
Tél : 03 80 55 00 00
fax : 03 80 53 93 63

infos@transtechnik.fr

www.transtechnik.fr

■ ***Bureau Paris :***

12 avenue des Andes
Bâtiment A
91967 COURTABOEUF Cedex
Tél: 03 80 55 00 00
Fax: 03 80 53 93 63

■ ***Bureau Lyon :***

Espace Florentin
71 chemin du moulin Carron
69570 DARDILLY
Tél: 03 80 55 00 00
Fax: 03 80 53 93 63