

entraînement

MOTEURS INTELLIGENTS

MAC 400 / MAC 800

m o t i o n
la force de la gamme !

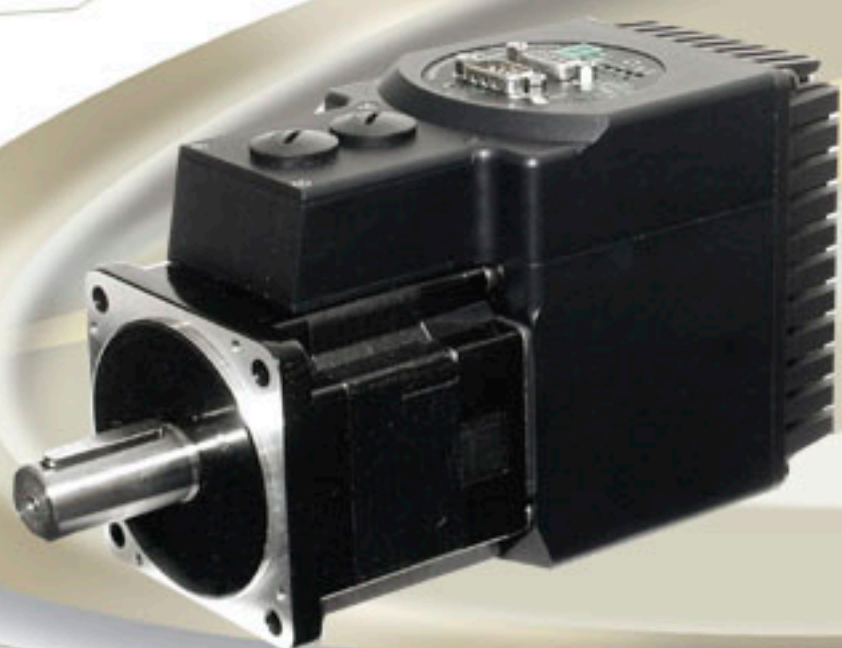

transtechnik
servomécanismes

The MAC motor[®]. AC-servo motors with integrated driver MAC400 and MAC800

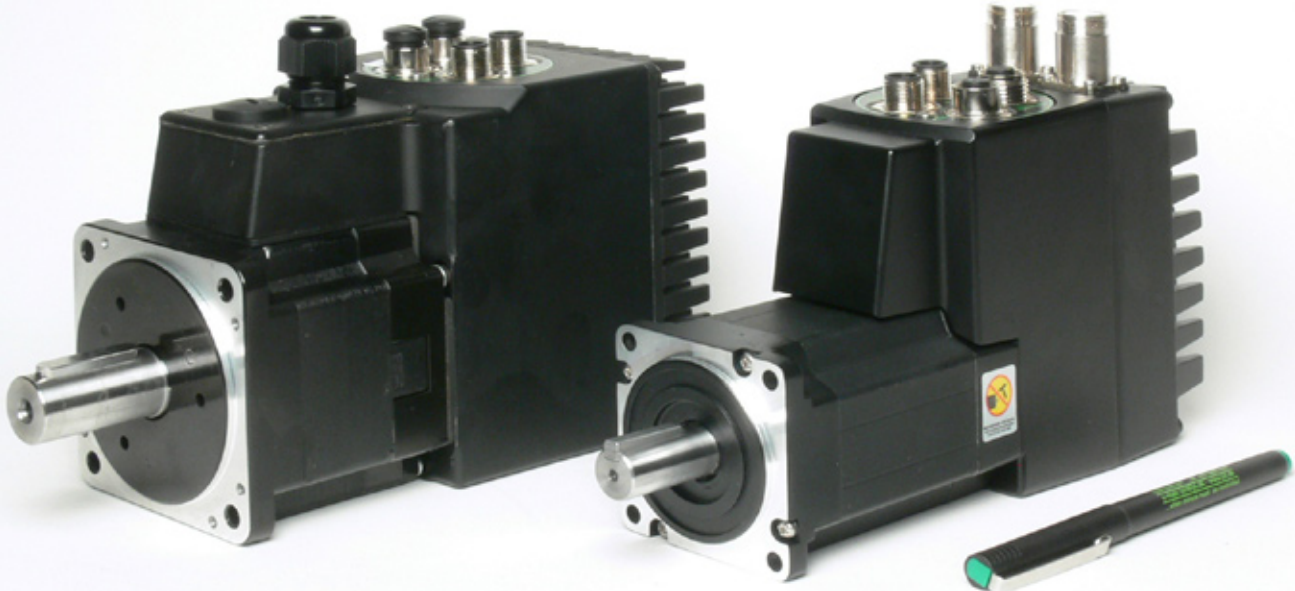

The MAC series of brushless servo motors with integrated electronics represents a major step forward. All the necessary electronics in a servo system are integrated in the motor itself.

In the past, a traditional motor system has typically been based on a central controller unit located remote from the motor. This configuration however has the negative effect that installation costs are a major part of the total expense of building machinery.

The basic idea of the MAC motors is to minimize these costs but also to make a component that is much better protected against electrical noise which can be a typical problem when

using long cables between the controller and motor.

The servo motor, hall sensor, encoder and electronics are specially developed by JVL so that together they form a closed unit in which the power driver and controller are mounted inside the motor in a closed section.

The advantages of this solution are:

- De-central intelligence.
- Simple installation. No cables between motor and driver.
- EMC safe. Switching noise remains within motor.
- Compact. Does not take space in cabinet. Typically a 3/5 core cable is used from PLC or similar to MAC motor.
- 115/230V AC for driver

voltage.

- 24VDC for control circuits.
- Option for built-in brake.
- Uses the same expansion modules as the MAC 50-141 series.
- Built-in mains supply filter.
- CE approved/UL pending.
- Low price.

Interface possibilities to the MAC motor:

- From PC/PLC with drive-commands via RS232/RS485/RS422
- Pulse/dir. or quadrature inputs.
- 10 bit $\pm 10V$ input for speed or torque control.
- A+B encoder output.
- Register mode via 4 inputs or serial commands
- Option for μ PLC built-in.

- Option for Fieldbus. Profibus-DP, CanOpen, Devicenet, High-speed serial bus etc.
- IP55 and IP65

The MAC motor can be controlled with $\pm 10V$ for speed or torque control with encoder feedback to one master motion controller.

Furthermore the MAC motor can replace an arbitrary step or servo system, being based on pulse and direction signals. There is a built-in electronic gear so that the MAC motor can simulate all possible step resolutions.

The MAC motor can thus replace all step- and servo-systems without change in the PLC/PC/controller software.

Adaptation/replacement of existing step motor/servo systems can therefore be achieved quickly.

Parameters are set up via the RS232 port from a Windows program.

The supply voltage is 115 or 230VAC for the drive and 24VDC for the control circuit. The motors offer a power of 400 and 750W. Standard flange so that

the MAC motor can replace other servo motors directly without mechanical changes.

The connector can be chosen as DSUB, M12 plug or cable glands. Backlash free and planetary gears in ratios of 3, 5, 12, 20, 100 can be delivered from stock.

System and feature overview

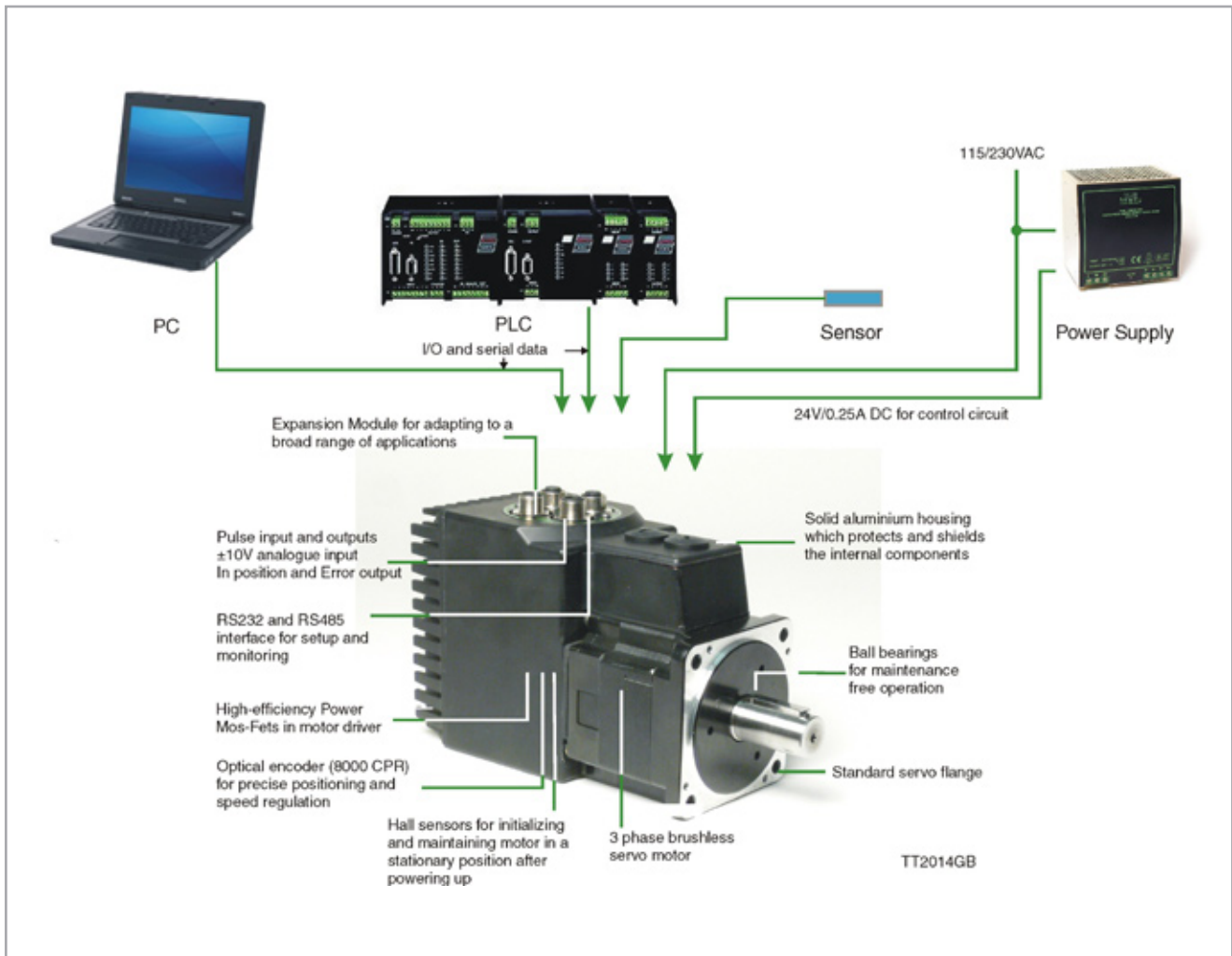

Modes of Operation (Basic Motor)

Gear Mode

In this mode the MAC motor functions as in a step motor system. The motor moves one step each time a voltage pulse is applied to the step-pulse input. Velocity, acceleration and deceleration are determined by the external frequency. Use of an encoder enables monitoring and adjustment during motor operation – a feature that is not possible with a standard step motor system. In addition, the MAC motor also provides a facility for electronic gearing at a keyed-in ratio with analogue speed offset.

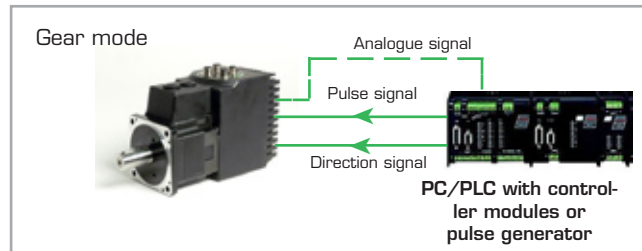

Positioning Mode

In this mode the MAC motor positions the motor via commands sent over the RS422 or serial interface. Various operating parameters can be changed continuously while the motor is running. This mode of operation is used primarily in systems where the Controller is permanently connected to a PC/PLC via the interface. This mode is also well suited for setting up and testing systems.

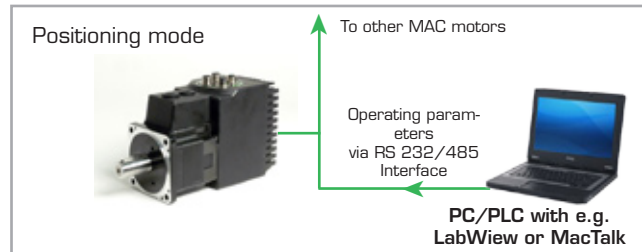

Serial Mode (FastMac)

In this mode the MAC motor's registers contain the parameter sets, positions, velocities, etc., required for the actual system. The registers can be selected and executed by a single byte sent via the serial interface. This mode provides maximum utilisation of the MAC motor's features since the MAC motor itself takes care of the entire positioning sequence.

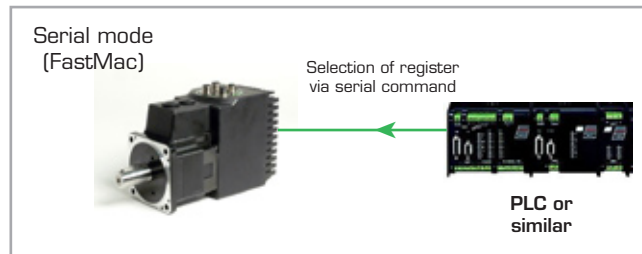

Velocity/Torque Mode

In this mode the MAC motor controls the motor velocity/torque via the analogue input. This mode is typically used for simple tasks or for applications in which an overall unit, such as a PC-board or PLC, controls velocity and positioning. Encoder A and B signals can be connected to the overall controller to close the servo loop.

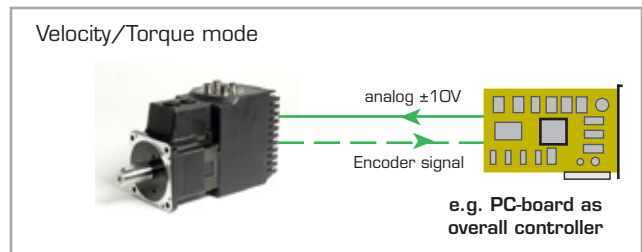

Torque versus speed

Conditions:
Supply voltage = Nominal 115 or 230VAC
Ambient temperature = 20°C
Torque setting = 100%
Load setting = 1.0

Operation above 3000 RPM can be done, but losses in the motor make it impossible to operate in this area continuously

--- = Peak Torque
— = Average Torque

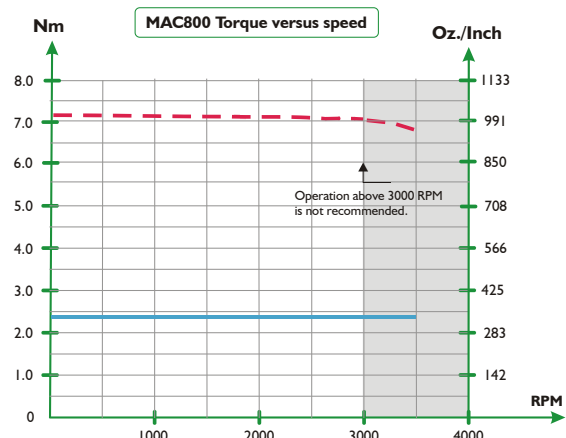
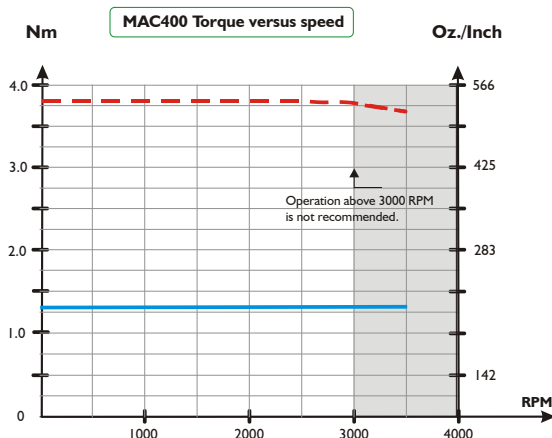

TT2250GB

Software, MacTalk

Setup save/open
The complete setup can be either saved or reloaded from a file using these buttons

System control
Use these buttons to save data permanently, reset the motor etc.

Error Handling
Use these fields to define error limits for the position range etc.

Input/Outputs
The functionality of the I/O's is specified here.

Motor status
This field shows the actual motor load, position and speed etc.

Inputs
This field shows the actual supply voltage, the speed at the pulse input and the voltage at the analogue input.

Errors
If a fatal error occurs, information will be displayed here.

Startup mode
The basic functionality of the MAC motor is setup in this field.

Profile Data
All the main parameters for controlling the motor behaviour are setup in this field.

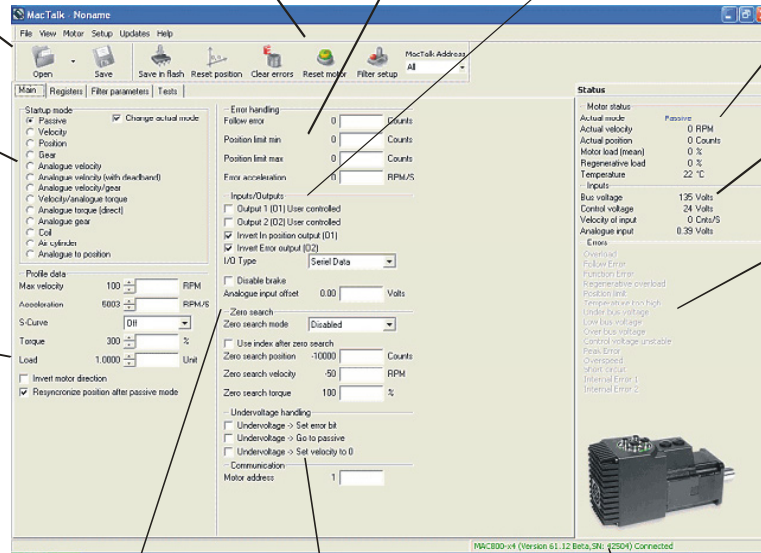

Zero Search
All the parameters regarding the position zero search can be specified here.

Undervoltage handling
Determine what must happen if the supply voltage gets too low..

MAC motor connection
information Always shows if the motor is on line or not.

TT2013GB

Block diagram

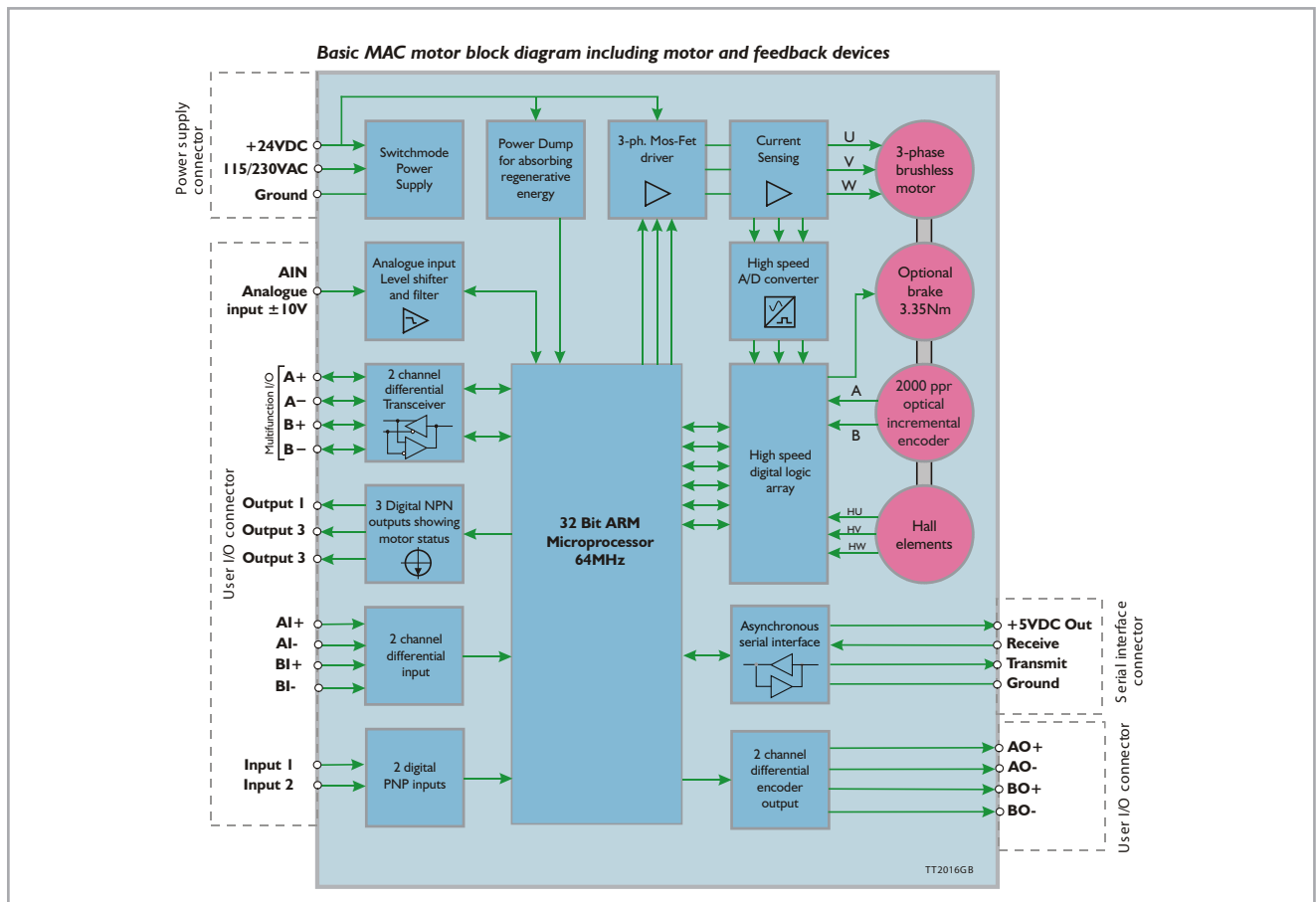

Expansion modules

The JVL Integrated motors utilizes the unique module concept. Plug in expansion modules adapt the motor to the application. You can choose connector type, D-Sub. (IP42), cable glands (IP67) or M12 connectors (IP67) and you can choose freely between Profibus, DeviceNet, CANopen or nano PLC communication. A High Speed and wireless

Basic Modules



MAC00-CS

Low cost module, connection directly to basic motor, serial communication not RS232.

- Low cost module
- Cable connected directly to basic motor connector
- User I/O connection
- 10 or 20 meter cable
- NPN outputs



MAC00-B1

General purpose module w/ Sub-D connectors:

- Ideal for pulse/direction, $\pm 10V$ input or RS232/422/485 interface
- Standard D- Sub conn.
- Home switch input
- LEDs to indicate status, Home switch status, Input power status
- PNP outputs



MAC00-B2

General purpose module w/Cable Glands: otherwise same as -B1.



MAC00-B4

General purpose module w/M12 connectors: otherwise same as -B1, but with USB interface.

- Dual supply support for MAC50-141

Programmable Modules



MAC00-R1

Nano-PLC Module w/Sub-D connectors: Stand-alone operation with 8 DI + 4 DO, RS232/485.

- Ideal for stand-alone operation with sequential program execution
- 8/4 Opto isolated in-/out. 5-30VDC
- Outputs up to 200mA. 10-30VDC
- LEDs to indicate output status
- Home+power status
- RS232/RS485 interface



MAC00-R3

Nano-PLC Module w/Cable Glands: otherwise same as -R1.



MAC00-R4

Nano-PLC Module w/M12 connectors: otherwise same as -R1.

Bus Modules



MAC00-FC4

CAN bus Module w/M12 connectors: Bus, 4 DI/DO and RS232.

- Control and setup
- Logic I/O for high speed start/stop
- CANbus/CANopen DS301/DSP402
- Optional with cable bushes (MAC00-FC2)
- End limit inputs
- Dual supply support for MAC50-141

module add to the possibilities. This means that you have possibilities as with no other motors on the market, and also important, you only pay for what you need. Moreover, if you do not find the feature you need, please contact us, and we will develop your own module. All modules can be delivered with or with cables of up to 20m length.

Bus Modules (continued)



MAC00-FD4

DeviceNet Module w/M12 connectors: Bus, 4 DI/DO and RS232.

- End limit inputs
- Dual supply support for MAC50-141



MAC00-FP2

Profibus Module w/ Cable Glands: Bus, 6 DI + 2 DO and RS232.

- Control and setup through 12Mbit/s profibus-DP
- Logic I/Os for High speed start/stop
- In position indication. Home switch
- LEDs to indicate status
- End limit inputs
- Dual supply support for MAC50-141



MAC00-FP4

Profibus Module w/M12 connectors: Bus, 4 DI/DO and RS232.

- End limit inputs
- Dual supply support for MAC50-141

High Speed Multi-Axis Modules



MAC00-FS1

High Speed Multi-axis Module w. D-Sub connectors and opto-isolated RS485.

- 9.6 - 460.8kbit
- Up to 255 axes (with repeaters)
- Command broadcast
- Pulse input or output
- Dual supply support for MAC50-141



MAC00-FS4

As module FS1 but with M12 connectors.



MAC00-FR4

High Speed Multi-axis Module w. M12 connectors: RS485 bus w/up to 255 axes.

- Multiaxis operation
- Compatible with SMCopen IEC 61131-3 automation software
- Advanced motion profiles for robot and xyz tables
- 4I/4O for user purposes
- Open hardware with PIC18F6520 for own sw.
- Dual supply support for MAC50-141

Wireless Modules



MAC00-FB4

Bluetooth Module w/M12 connectors. Controlled from PC, PDA, Cellphone or PLC with Bluetooth

- Standard Bluetooth SPP profile
- Pulse input or output
- External connector for antenna
- Dual supply support for MAC50-141



MAC00-EW4

WLAN Module w/M12 connectors. Controlled from PC, PDA, Cellphone or PLC with WLAN

- Standard WLAN profile
- Pulse input or output
- External connector for antenna
- Dual supply support for MAC50-141

Technical Data

GENERAL					
Technology		AC-servomotor with built-in 2000 PPR encoder, hall sensor and 3 phase servo amplifier/controller.			
Controller Type		MAC400-D2 and D3	MAC400-D5 and D6 w. brake	MAC800-D2 and D3	MAC800-D5 and D6 w. brake
Con- troller capac- ity	Rated output @ 3000RPM	400W (0.84hp)	400W (0.84hp)	750W (1.00hp)	750W (1.00hp)
	Rated Torque RMS	1.3Nm (184oz-in)	1.3Nm (184 oz-in)	2.38Nm (337.04oz-in)	2.38Nm (337.04oz-in)
	Peak Torque	3.8Nm (538.13oz-in)	3.8Nm (538.13oz-in)	6.8Nm (962.96oz-in)	6.8Nm (962.96oz-in)
	Inertia (kgcm ²)/(oz-in-s ²)	0.34/0.004815	0.36/0.005098	0.91/0.01289	1.13/0.016
	Length	191mm (7.52")	224.5mm (8.84")	174mm (6.85")	210mm (8.27")
	Weight (without expansion module)	2.3kg (5.11lb)	2.8kg (6.17lb)	3.5kg (7.716lb)	4.3kg (9.48lb)
Speed range		0-3000RPM with full torque. Max 3500 RPM.			
Amplifier control system		Sinusoidal wave PWM control. 20kHz switching.			
Filter:		6th order filter with only one inertia load factor parameter to be adjusted. Expert tuning also available.			
Feedback: Standard incremental:		Incremental A and B encoder 8192 CPR. (Physical 2048 PPR) MAC400. 8000CPR (Physical 2000PPR) MAC800.			
Optional absolute multiturn encoder:		Encoder 65535 CPR and 4096 rev.			
Input power supply		115/230/240VAC for driver circuit. 12-32VDC for control circuit. Consumption at 115-240VAC - see power supply section. Control circuitry consumption: MAC800D2 and 3 (wo/brake) =0.25A @ 24VDC(6W). Control circuitry consumption: MAC800D5 and 6 (w/brake) =0.75A @ 24VDC(18W).			
Control mode		<ul style="list-style-type: none"> * ±10V Speed and Torque. A+B encoder outputs * Pulse/direction or 90° phase shifted A+B (Incremental). * RS422 or RS232 (5V) position and parameter commands * Gear mode with analog input speed offset + various options. * Sensor zero search or mechanical zero search. 			
Flange and shaft dimension		MAC800: Front: 80x80mm. Rear: 80x120mm. Shaft Ø19mm MAC400: Front 60x60mm. Rear 60x115mm. Shaft Ø14mm			
POSITION (pulse inputs)					
Command input pulse		Pulse/direction or 90° phase shifted A+B. RS422			
Input frequency		0-8 MHz. 0-1MHz with input filter			
Electronic gear		A/B: A= -10000 to 10000, B=1 to10000. Simulation of all step resolutions.			
Follow error register		32 bit			
In position width		0-32767 pulse			
Position range		32 bit. Infinity, Flip over at ±2 ³¹ pulses.			
POSITION (serial communication)					
Communication facility		From PLC, PC etc via RS422 or asynchronous serial port RS232 with special cable. MacTalk JVL commands, special commands with high security.			
Communication baud rate		9600 to 230400 bit/sec (1Mbit/sec motor-to-motor)			
Position range		±67 000 000			
Speed range		0-3000 RPM.			
Digital resolution		0.3606 RPM			
Acceleration range		250 – 444675 RPM/sec			
Addressing		Point to point on RS422. Up to 32 units on the same serial RS232/RS485 interface with built-in expansion module. Address range 1-254			
Speed variance		Max ±4 RPM variance between command and actual speed.			
SPEED/ TORQUE					
Analogue speed/torque input. 12bit		±10V. 10k0hm input resistance. Voltage range max. -10 to +32VDC. Offset typical ±50mV.			
Sampling rate at analogue input		750 Hz			
Encoder output signals		A+, A-, B+, B-, RS422. Line driver 5V outputs (SN75176). 90° Phase shifted.			
Analogue speed input		+voltage -> CW rotation. Shaft view			
Zero speed determination.		0 - rated speed.			
Speed variance at rated speed		Initial error @20°C: ±0,5%		Power Supply: ±10%: 0.0%	
		Load 0-300%: ±0.0%		Ambient temperature 0-40°C: ±0,1%	
Torque limit in speed mode		0-300% by parameter			
Analogue torque input		+voltage (positive torque) -> CW rotation. Shaft view			
Torque control accuracy		±10% @ 20°C (Reproducibility)			
VARIOUS					
Fatal error brake		Controlled deceleration by fatal error. Adjustable 250 – 444.675 RPM/sec.			
Regenerative		Integrated power dump. External attachment is possible			
Protective functions.		Error trace back. Overload I ² t, follow error, function error, regenerative overload (over voltage), software position limit. Abnormality in flash memory, under voltage, over current, temperature too high.			
LED functions		Power (Green LED), Error (Red LED)			
Output signals		3 general purpose NPN 30V/25 mA outputs. Error and In position.			
Zero search		1: Automatic zero search with sensor connected to input (2 formats) 2: Mechanical zero search without sensor. (Torque controlled)			
Shaft load maximum		MAC800: Radial load: 18kg (20mm from flange). Axial load: 11kg MAC400: Radial load: 24.5kg (13.5mm from flange). Axial load: 9.8kg.			
Optional brake (-D5/D6 option)		Controlled automatic or from input. 3.25Nm (MAC800), 1.29Nm (MAC400)			
Rated power rate. (motor)		62.8 kW/s			

Technical Data (continued)

Mechanical time constant. (motor)	0.428±10% ms					
Electrical time constant. (motor)	4.122±10% ms					
Standards	CE approved/UL pending					
Protection	IP55 and IP65					
Basic motor connector: (Other functions available with expansion modules)	RS232 serial interface (1)	IN/OUT: User I/O connector (2)		Power (3)	Power (control circuitry)	
	1: +5VDC out	1: Ground	5: A+ Multifunction/I/O	1:P+	L1: 115/230VAC	PD: Power Dump
	2: Rx (5V)	2: Analog in	6: A- Multifunction/I/O	2:P-	N: 115/230 VAC	BO: Bus output
	3: Tx (5V)	3: Out1 (Error)	7: B+ Multifunction/I/O		PE: Earth	CM: Common
	4: Ground	4: Out2 (In pos.)	8: B- Multifunction/I/O		PE: Earth	
Basic motor connector: (J1B) (Not supported by expansion modules at present time)	1: GND	6: IN1	11: B+	16: BO-		
	2: AIN	7: A+	12: Ao-	17: BI-		
	3: O1 (Error)	8: IN2	13: B-	18: AI+		
	4: O2 (Input)	9: A-	14: BO+	19: GND		
	5: O3	10: A0+	15: BI	20 A11		

Power Supplies

The Integrated MAC400 and MAC800 motors have a complete 90-240VAC power supply built in and furthermore only requires an 18 to 30 VDC for the control circuitry. Having 2 independent supply circuits offer the feature

that the supply voltage for the power circuitry (90-240VAC) can be removed for safety reasons while the control circuitry can keep operating and thereby keep the position counter updated and keep other vital functions.

External Power Supplies

For external low voltage supply JVL can deliver a wide variety of high quality switchmode powersupplies. Power Supply PSU24-075 is recommended for control power supply. For detailed information ask for separate

MAC400 supply connections

MAC800 supply connections

Remove the lid to access the internal supply terminals

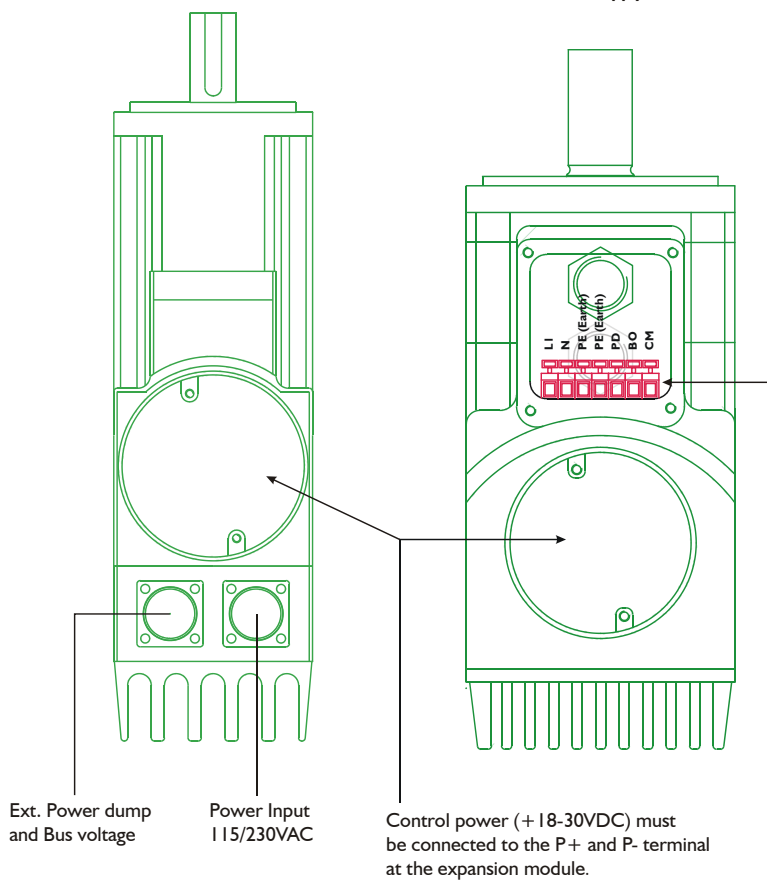

Main power, internal bus voltage and power dump is accessible through these spring contacts placed under the top lid. Main power must be 115 or 230VAC.

MAC motor selection chart

MAC Motors feature overview including expansion modules

Feature \ Type	Unbalanced async. serial interface For setup/sending commands	Balanced async. serial interface For setup/sending commands	±10V Analogue input For controlling speed/torque Also used for zero search	Pulse inputs Accepts pulse and direction or quadrature encoder signal	Pulse outputs 90 degree phase shifted outputs from internal encoder	Digital user inputs For control of program flow or motor start/stop	Digital user outputs For indicating the motor status or as output from the program	Ext. connector type	Protection class	Integrated brake
Basic MAC motors										
MAC50,95,140,141-A1 Basic MAC motors IP42	5V TTL 19.2kbaud Full Duplex	RS422 3) 19.2kbaud Full Duplex	✓	RS422 3) 2.5Mhz or 150kHz (LP)	RS422 3) 4096 cpr	No	Motor stat. 2 x NPN 25mA	AMP Molex JST	IP42	
MAC50,95,140,141-A3 Basic MAC motors IP67	5V TTL 19.2kbaud Full Duplex	RS422 3) 19.2kbaud Full Duplex	✓	RS422 3) 2.5Mhz or 150kHz (LP)	RS422 3) 4096 cpr	No	Motor stat. 2 x NPN 25mA	AMP Molex JST	IP67 1)	
MAC400/800-D2/D5 Basic MAC motors IP55 or IP65	5V TTL 19.2kbaud Full Duplex	RS422 3) 19.2kbaud Full Duplex	✓	RS422 3) 2.5Mhz or 150kHz (LP)	RS422 3) 8192/ 8000 cpr	No	Motor stat. 2 x NPN 25mA	AMP Molex JST	IP55/ 65	
MAC400/800-D3/D6 Basic MAC motors IP55 or IP65	5V TTL 19.2kbaud Full Duplex	RS422 3) 19.2kbaud Full Duplex	✓	RS422 3) 2.5Mhz or 150kHz (LP)	RS422 3) 8192/ 8000 cpr	No	Motor stat. 2 x NPN 25mA	AMP Molex JST	IP55/ 65	✓
Expansion modules										
MAC00-CS Conn. module w/cable glands No electronic features added	5V TTL 19.2kbaud Full Duplex	RS422 3) 19.2kbaud Full Duplex	✓	RS422 3) 2.5Mhz or 150kHz (LP)	RS422 3)	No	Motor stat. 2 x NPN 25mA	Cable Gland	IP67 1)	
MAC00-B1 Connector module w/DSUB connectors	RS232 19.2kbaud Full Duplex	RS422 3) 19.2k Full Duplex	✓	RS422 3) 2.5Mhz or 150kHz (LP)	RS422 3)	No	Motor stat. PNP 10-32V 100mA	DSUB	IP42	
MAC00-B2 Connector module w/cable glands 2)	RS232 19.2kbaud Full Duplex	RS422 3) RS485 19.2k Full Duplex	✓	RS422 3) 2.5Mhz or 150kHz (LP)	RS422 3)	No	Motor stat. PNP 10-32V 100mA	Cable Gland	IP67 1)	
MAC00-B4 Connector module w/M12 connectors	RS232 19.2kbaud Full Duplex	RS422 3) RS485 19.2k Full Duplex	✓	RS422 3) 2.5Mhz or 150kHz (LP)	RS422 3)	No	Motor stat. PNP 10-32V 100mA	M12	IP67 1)	
MAC00-R1 Nano PLC w/ DSUB connect.	RS232 19.2kbaud Full Duplex	RS485 19.2kbaud Half Duplex	✓	No	No	6 Inputs Opto isol. 5-30V	4 Outputs PNP 10-30V 300mA	DSUB	IP42	
MAC00-R3 Nano PLC w/cable glands 2)	RS232 19.2kbaud Full Duplex	RS485 19.2kbaud HalfDuplex	✓	No	No	6 Inputs Opto isol. 5-30V	4 Outputs PNP 10-30V 300mA	Cable Gland	IP67 1)	
MAC00-R4 Nano PLC w/M12 connectors	RS232 19.2kbaud Full Duplex	RS485 19.2kbaud HalfDuplex	✓	No	No	6 Inputs Opto isol. 5-30V	4 Outputs PNP 10-30V 300mA	M12	IP67 1)	
MAC00-FS1 High speed serial RS485 Multiaxis	RS232 19.2kbaud Full Duplex	RS485 460 kBaud Opto isol.	✓	RS422 3) 2.5Mhz or 150kHz	RS422 3)	4 Inputs Opto isol. 5-30V	2 Outputs PNP 10-32V 25mA	DSUB	IP42	
MAC00-FR4 High speed serial RS485 Multiaxis. Interf. to IEC61131-1	No	RS485 230kbaud Opto isol.	✓	No	No	4 Inputs Opto isol. 5-30V	4 Outputs PNP 10-30V 300mA	M12	IP67 1)	
MAC00-FP2 Profibus DP w/cable glands 2)	RS232 19.2kbaud Full Duplex	No	✓	No	No	6 Inputs Opto isol. 5-30V	Motor status PNP 10-32V 25mA	Cable Gland	IP67 1)	
MAC00-FP4 Profibus DP w/M12 connectors	RS232 19.2kbaud Full Duplex	No	✓ 4)	No	No	4 Inputs Opto isol. 5-30V 4)	Motor status PNP 10-32V 25mA 4)	M12	IP67 1)	
MAC00-FC4 CANopen w/M12 connectors	RS232 19.2kbaud Full Duplex	No	✓ 4)	No	No	4 Inputs Opto isol. 5-30V 4)	2 Outputs PNP 10-32V 25mA 4)	M12	IP67 1)	
MAC00-FD4 DeviceNet w/M12 connectors	RS232 19.2kbaud Full Duplex	No	✓ 4)	No	No	4 Inputs Opto isol. 5-30V 4)	2 Outputs PNP 10-32V 25mA 4)	M12	IP67 1)	
MAC00-FB4 Bluetooth module	RS232 19.2kbaud Full Duplex	RS422 3) RS485 19.2k Full Duplex	✓	RS422 3) 2.5Mhz or 150kHz (LP)	RS422 3)	No	Motor stat. PNP 10-32V 100mA	M12	IP67 1)	

1) IP67 protection class is only possible if the basic MAC motor also offers IP67

2) Can be ordered without cable (eg. MAC00-CS) or with cable in metre 2, 10 or 20 (eg. MAC-CS-10).

3) Either pulse input, pulse output or serial must be chosen. Not all of them at the same time.

4) Only a total of 4 I/O terminals are available.

TT20126B

Planetary and cycloidal (robot) gearheads

JVL offers a wide range of both planetary and cycloidal (robot) gears. They fit either directly or by means of

- Sealed Ball Bearings
- High Reliability, High Efficiency Design
- NEMA Mounting Standards

adaptors on the MAC400 and MAC800 motors. gear ratios can be from 1:3 to 1:1000. See separate datasheets for

- High Shaft Loading Capacity
- Low Backlash Design
- Strong, Caged Roller Bearings

detailed information

- Precision Input Pinion with Balanced Clamp Collar

HTRG type gears:

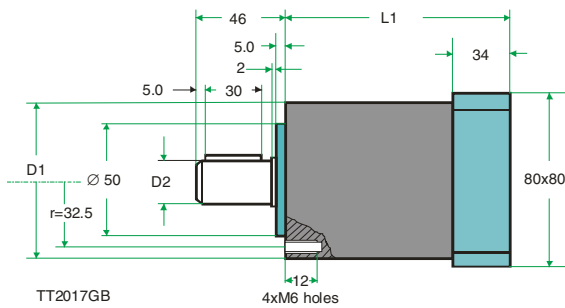

TT2017GB

4xM6 holes

HSPG type gears:

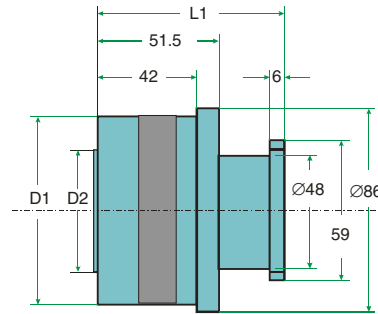

TT2010GB

All dimensions in mm

Model.	Back-lash [arc min]	Gear ratio	Efficiency [%]	Rated torque >10000 Hours [Nm]	Emerg stop Torque [Nm]	Inertia at motor shaft [kg*cm ²]	Noise [dB(A)]	Radial load @ mid length. 100rpm [N]	Axial load [N]	Weight [kg]	L1 [mm]	D1 [mm]	D2 [mm] (h7)
HTRG08N003MHP70119MC	15	3	97	40	180	0.74	<70	1300	1460	4.0	117.5	85	19
HTRG08N005MHP70119MC	15	5	97	50	200	0.46	<70	1300	1460	4.0	117.5	85	19
HTRG08N012MHP70119MC	15	12	94	70	250	0.48	<70	1300	1460	4.6	142	85	19
HTRG08N020MHP70119MC	15	20	94	70	250	0.48	<70	1300	1460	4.6	142	85	19
HSPG140-33-SAA-N23	<1	33	>90	37	670	-	-	11500	17000	6.4	-	140	92
HSPG140-139-SAA-N23	<1	139	>90	78	670	-	-	11500	17000	6.4	-	140	92





Mechanical dimensions MAC400

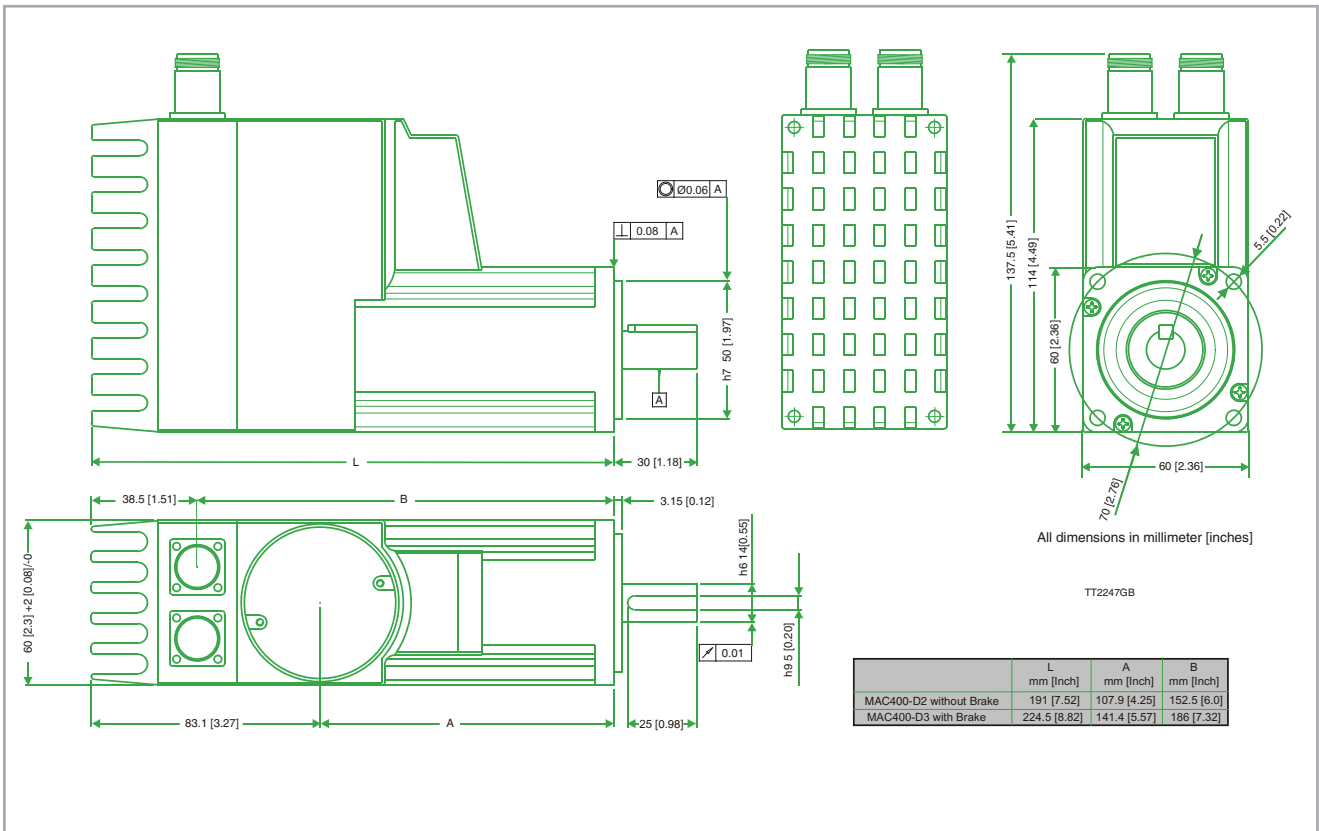

Mechanical dimensions MAC800

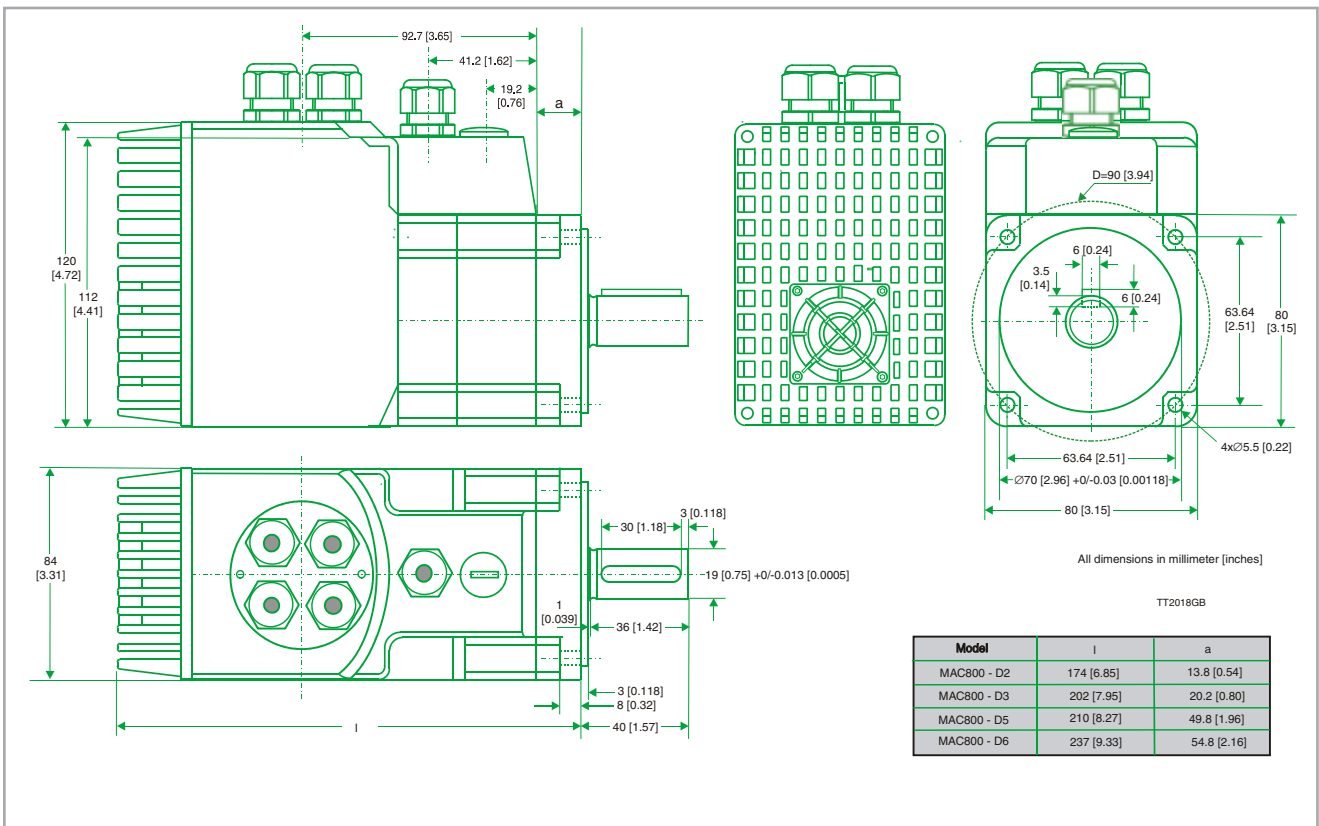



AC servo motors MAC400 and MAC800

Ordering information

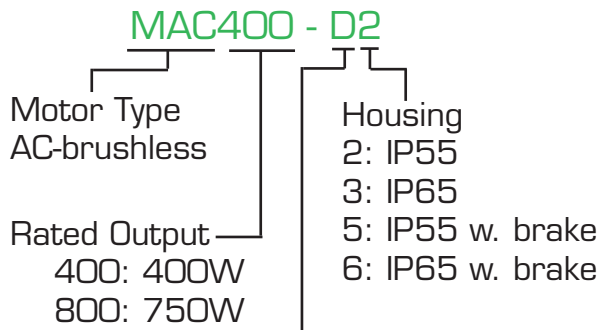

D: Standard. 3000 rpm.

Accessories

RS232-9-1	Cable for PC
RS232-9-1-Mac	Cable for PC with built in RS232 converter
MacTalk	Software for set-up of Mac motor
MacRegIO	Expert tool for programmers
MacCommOCX	OCX/ActiveX driver for Windows
MAC00-xx	Expansion modules. See page 5
PSU24-075	24VDC Power Supply for control circuit
WP0203	Mains supply cable - 3m, 230VAC for MAC400
WP0303	Mains supply cable - 3m, 115VAC for MAC400
WP0102	Brake cable - 2m for MAC400

Get started quickly!

Starter Kit (MAC400-D1-KIT): Contains all necessary parts to get started

The kit consists of: Motor, Expansion Module, Software, PC Cable and Power Supply

- MAC 400-D2
- MAC00-B1
- MacTalk
- RS232-9-1
- PSU24-060



Starter Kit (MAC800-D1-KIT): Contains all necessary parts to get started

The kit consists of: Motor, Expansion Module, Software, PC Cable and Power Supply

- MAC 800-D2
- MAC00-B1
- MacTalk
- RS232-9-1
- PSU24-060

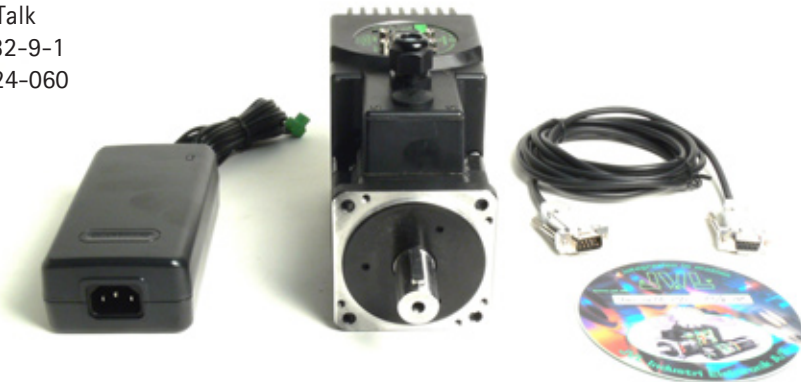

JVL Industri Elektronik A/S
 Blokken 42
 DK-3460 Birkerød, Denmark
 Tel: +45 4582 4440
 Fax: +45 4582 5550
 E-mail: jvl@jvl.dk www.jvl.dk





■ ***Siège social &
service technique :***

Z.A Ahuy-Suzon
17 rue des grandes Varennes
B.P 46 - 21121 AHUY
Tél : 03 80 55 00 00
fax : 03 80 53 93 63

infos@transtechnik.fr

www.transtechnik.fr

■ ***Bureau Paris :***

12 avenue des Andes
Bâtiment A
91967 COURTABOEUF Cedex
Tél: 03 80 55 00 00
Fax: 03 80 53 93 63

■ ***Bureau Lyon :***

Espace Florentin
71 chemin du moulin Carron
69570 DARDILLY
Tél: 03 80 55 00 00
Fax: 03 80 53 93 63